



Desiccators and Drying Cabinets

Glove Boxes for working in a controlled environment

- » stable
- » functional
- » custom-made

All information in our catalogue is based on current technical knowledge, experience and manufacturers' data. Users should check the suitability of parts and materials described in the catalogue before use.

BOHLENDER does not accept any warranty as to suitability and fitness of purpose of the materials and products described in this catalogue. Users should avoid making any assumptions on, or interpretations of, the data herein.

All products are subject to technical modification without prior notice.

The following are the registered trademarks of the respective organisations:

Plexiglas® by Evonik Röhm GmbH

NEW

New products are shown with this icon.

BESTSELLER

Our best sellers

CE

These products conform to the CE regulations. A certificate is supplied with our operating instructions upon delivery.

Dear valued customers,



In the latest version of our SICCO Catalogue you will find again an enlarged choice of SICCO Desiccators, Drying cabinets and Glove Boxes.

One of our new products is the SICCO Star Desiccator Double on page 17. This model has been designed for products in landscape formats. Through its swing doors, you can use the whole width of the desiccator for loading and removing your products.

Often we have been asked for our Mini Desiccators with borosilicate glass panels. At your suggestion we have created our SICCO Mini-Vitrum Desiccator which you will find on page 29. It is perfectly suitable for the insertion of hot samples and chemically highly resistant against most acids and organic substances.

We also would like to satisfy your needs and ideas that cannot be covered by our standard range of desiccators and glove boxes. Ask us and explain what you need. As a manufacturer, we are able to offer desiccators, drying cabinets and glove boxes as custom manufactures. This is easier and faster than you may expect – already starting with 1 piece.

Our experts are looking forward to new challenges!

Your

A handwritten signature in blue ink, appearing to read 'V. Bohlender'.

Volker Bohlender

Managing Director



6 Fields of application
of Desiccators

8 Modifications/Made to measure

10 Guide to your ideal product

For dust- and humidity-free storage
or drying with Silicagel.



11 Desiccators for drying/storage

12 Desiccators for drying/storage

19 Mini-Desiccators

25 Desiccator Wall

26 Vitrum Desiccators

31 Desiccators with UV protection and
Black

For storage of reactive substances.



39 Desiccators for gas-filling

For long-term storage.



45 Automatic-Desiccators

For storage of electronic components
in antistatic atmosphere.



51 Antistatic-Desiccators



For quick drying of substances and
O₂/CO₂-free storage

»» 57 Vacuum-Desiccators

For safe handling of contaminated
substances.

»» 61 Glove Boxes/
Extractor Hoods

62 Glove Boxes
76 Extractor Hoods

77 Accessories

87 Technical Information

88 Drying performance
96 Effective and utility space
97 Cleaning, assembly of shelves
98 Stacking of desiccators,
safe wall-mounting
99 Efficient use of Silicagel
100 Optimise drying performance
101 Cable lead-ins
102 Gas Dosing Controller
103 Gas-Saving Valve
104 Iris Ports, Closing lid for glove port
107 Materials

105 Company

Fields of application of Desiccators.

Appropriate solutions for any requirements

SICCO Desiccators and drying cabinets are used in different sectors. Available in different sizes as well as with a maximum of flexibility and functionality, they are covering the full spectrum of protected drying and storage.

Discover the large choice by means of some real life examples...



Electrical industry: **Protected temporary storage of electronic components.**

For example SICCO Antistatic-Desiccators that protect sensitive electronic components such as boards against humidity and particles from the ambient air and in antistatic atmosphere.



Photographic industry: **Reliable equipment storage.**

For example the SICCO Maxi 2-Desiccator that is ideal for long-time storage of sensitive photo equipment and optical components in best possible conditions.



Tobacco industry: **Product-friendly long-term storage of tobacco and paper.**

For example the SICCO Auto-Star-Desiccator for automatic drying at constant humidity between 20 and 30%.



Metallography: **Stable storage of minerals and stones.**

For example the SICCO Maxi 1-Desiccator as robust depository with a frame made of aluminium profiles and shelves made of stainless steel for a total overload up to 160 kilos.



Museums and galleries:

Safe keeping of valuable pictures and virtu.

For example the SICCO Super-Big-Star-Desiccator with conserving effect, including hygrometer and tubing with quick couplings for gas-filling with pre-dried air.



Medicine:

Protection of sensitive tissue samples.

For example the SICCO Maxi 1-Desiccator that is usable with up to 34 shelves and a temperature resistance of -20°C up to $+70^{\circ}\text{C}$.



Industry/Laboratory:

Safe storage of retained samples.

For example the SICCO Super-Star-Desiccator that is usable with up to 26 acrylic glass shelves, circular rubber seal and cylinder lock.



Industry:

Space-saving and dry storage of labels.

For example the SICCO Maxi 1-Desiccator that is usable with up to 34 shelves, tray and hygrometer.



Laboratory:

Non-hazardous storage of bottles with toxic substances.

For example with the SICCO Maxi 2-Desiccator that has two separate compartments with door, tray and hygrometer.

Standard plus: our modifications...

The SICCO range already offers many options and a wide range of accessories for different applications. Moreover, we offer you to adapt our standard products according to your requirements. Sometimes it is only a small detail that has to be modified or added such as a modified door stop or additional entry ports.

Your benefit is an individual product as well as fast availability due to short-term realization of the modification. And what is your special request? We will be pleased to assist you: Just give us a call **+49 (0) 9346 9286-0** or send us the enclosed "Made to measure"-sheet by fax.

Standard

Modification



A big flap instead of the split door for the supreme chamber.



Open-minded for your plans: A closing device with gas-pressure spring instead of a traditional hinge-joint.



Open for new possibilities - for example a desiccator wall with additional ports for one pair of gloves per compartment.



Flexible: additional cable lead-ins can be placed freely, whether for further electronic devices or the insertion of probes and tubes.

Or 100 Percent Individuality: Made to measure

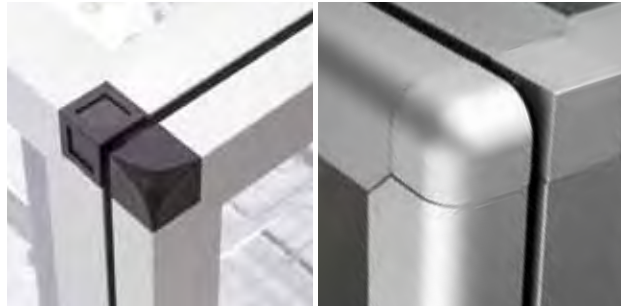

The SICCO standard product range already covers many extras and special requests. You are looking, however, for a special solution. Something that even BOHLENDER does not have in stock?

In this case we as a manufacturer offer “made to measure”-service. Just talk to our experts about your ideas, we will be glad to assist you – beginning with the construction and realizing manufacture exactly as per your request, starting with 1 piece. We only need a drawing (an approximate draft is enough) and some information.

Just give us a call **+49 (0) 9346 9286-0** or send us the enclosed “Made to measure”-sheet by fax. We will contact you to discuss details. Afterwards, you will receive our non-binding and cost-free quotation.

Check-list for your Desiccator “made to measure”:

- » What is the application the desiccator is used for?
- » Which outside dimensions should your desiccator have?
- » What should be stored?
- » What material do you need for the desiccator panels?
- » How many shelves do you need?
- » What is the maximum expected weight? Per shelf, per desiccator?
- » Which accessories do you need (lock, connectors for gas-filling ...)?
- » How many desiccators do you need?
- » What is the maximum budget you would like to spend per desiccator?

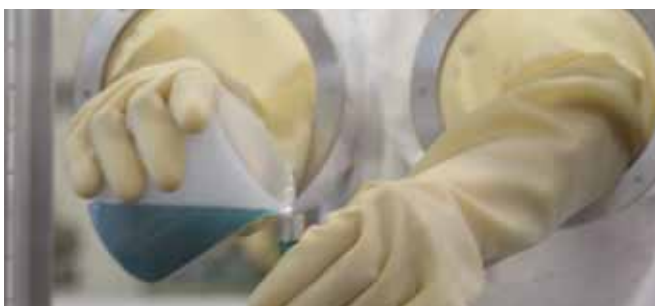
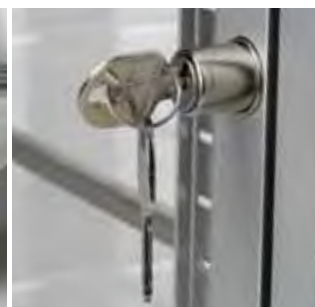
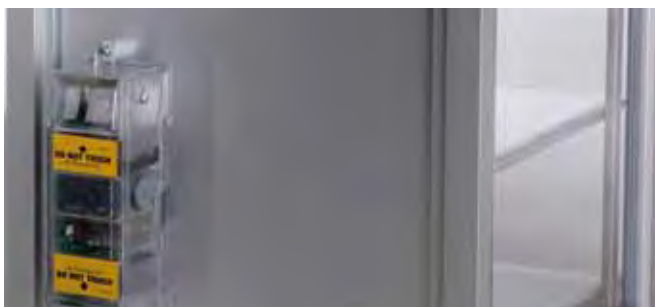

Guide to your ideal product.

You are not sure what is the best SICCO product for your purpose? No problem: In this chart you will find the ideal product concerning application and requested size.

YOUR REQUIREMENTS	YOUR REQUIRED SPACE			
	Mini max. 212x162x180 mm (W x H x D) per compartment	Star max. 260x480x330 mm (W x H x D) per compartment	Big max. 495x500x540 mm (W x H x D) per compartment	Maxi max. 495x1.030x540 mm (W x H x D) per compartment
Humidity- and dust-free storage or drying of objects and/or substances	Mini-Desiccators Basic, Page 19 Mini-Desiccators Premium, Page 20	Star-Desiccator, Page 12 Star-Desiccator Horizontal, Page 13 Tower-Star-Desiccator, Page 13 Star-Desiccator Double, Page 17	Big-Star-Desiccator, Page 14 Big-Star-Desiccator Low, Page 16 Desiccator-Wall, Page 25	Maxi-Desiccator Horizontal, Page 14 Maxi 1-Desiccator, Page 15 Maxi 2-Desiccator, Page 15
Additionally temperature adjustable through heating with air circulation		Star-Thermo-Desiccator, Page 18		
Additional safety through integrated lock	Mini-Desiccators Secure Box, Page 21			
Mobile version with handy grip	Mini-Desiccators Mobile, Page 22			
Insertion of hot materials (up to 300°C) or especially aggressive media	Mini-Vitrum Desiccators, Page 29	Star-Vitrum-Desiccator, Page 26 Star-Vitrum-Desiccator Horizontal, Page 27	Big-Star-Vitrum-Desiccator, Page 27	Maxi 1-Vitrum-Desiccator, Page 28 Maxi 2-Vitrum-Desiccator, Page 28
Storage of light-sensitive substances	Mini-Desiccators Protect, Pages 33-34	Star-Desiccator Protect, Page 31	Big-Star-Desiccator Protect, Page 32	Maxi 1-Desiccator Protect, Page 32 Maxi 2-Desiccator Protect, Page 33
Storage of substances to the exclusion of light and UV radiation	Mini-Desiccators Black, Page 38	Star-Desiccator Black, Page 35	Big-Star-Desiccator Black, Page 36	Maxi 1-Desiccator Black, Page 36 Maxi 2-Desiccator Black, Page 37
Storage of reactive substances respectively toxic chemicals with gas-filling equipment	Mini-Desiccators for gas-filling, Page 44	Super-Star-Desiccator, Page 40 Super-Star-Desiccator Vitrum, Page 41	Super-Big-Star-Desiccator, Page 42	Super-Maxi 1-Desiccator, Page 42 Super-Maxi 2-Desiccator, Page 43
Long-term storage with automatic drying at constant humidity between 20 and 30%		Auto-Star-Desiccator, Page 47 Auto-Star-Desiccator Vitrum, Page 48	Auto-Big-Star-Desiccator, Page 48 Auto-Desiccator-Wall, Page 50	Auto-Maxi 1-Desiccator, Page 49 Auto-Maxi 2-Desiccator, Page 49
Storage of electronic components in antistatic atmosphere	Mini-Desiccators Antistatic, Page 54	Star-Desiccator Antistatic, Page 52	Big-Star-Desiccator Antistatic, Page 52 Desiccator-Wall Antistatic, Page 55	Maxi 1-Desiccator Antistatic, Page 53 Maxi 2-Desiccator Antistatic, Page 53
Storage of sensitive products in vacuum for especially quick drying		Vacuum-Desiccators, Pages 58-60		
Safe working with sensitive mixtures in isolated atmosphere	Glove Boxes and Extractor Hoods, from page 62			

Your requirement is not part of the list? Through the modification of our standard range and our “made to measure”-service, we will find the best solution for any enquiry. Let us know your wishes: either through the enclosed enquiry form or with a call on **+49 (0) 9346 9286-0**. We are looking forward to talking to you!

SICCO Desiccators for drying/storage

SICCO Desiccators are designed for storing or drying humidity sensitive products using Silicagel. The tight fitting door protects the contents from contamination of the atmosphere. The controlled environment

inside the desiccators is ideal for storing reference materials, retained samples, metallographic specimens, tobacco and DNA samples.

Feature Summary

- » Reinforced aluminium frame with acrylic or borosilicate glass panels
- » Door with magnetic catch and circular rubber seal
- » Non-slip rubber feet or four casters (two of the casters with brakes)
- » Easy to read electronic hygrometer
- » Variable height shelves made of polycarbonate, stainless steel or aluminium
- » Telescopic shelves
- » Desiccant tray
- » Star-Desiccators include Silicagel

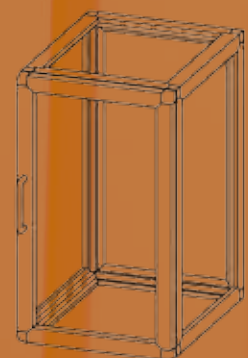

SICCO BENEFITS

- » reinforced aluminium frame with acrylic panels
- » door with magnetic catch and circular rubber seal
- » easy to read electronic hygrometer
- » variable height shelves
- » telescopic shelves
- » non-slip rubber feet



BESTSELLER

SICCO Star-Desiccator

Panels:	Material:	Temperature resistance:	Use:	Stand:
clear	PMMA	-20 °C to +70 °C	normal pressure	rubber feet

Specification:

Aluminium frame with panels made of acrylic glass, including four shelves made of polycarbonate, tray, hygrometer and desiccant, usable with up to 26 shelves, stackable.

Cat. No.:	V 1871-07
Overall dimensions* W x H x D mm	310 x 525 x 375
Usable interior space W x H x D mm	260 x 480 x 330
Capacity liters	51
Weight kg/approx.	7
Maximum all-over load per shelf kg	10
Total all-over load kg	30





SICCO
Practical Tip

German Merk » Assembly

You do not have much space on your worktop and would like to stack your desiccators safely?

Just use our Connectors for Desiccators.

page 84, 98



Add. accessories
Page 77-86.

*Overall dimensions are indicated as follows: width including hinge, height starting from base, depth without handle

SICCO Tower-Star-Desiccator

Panels:	Material:	Temperature resistance:	Use:	Stand:
clear	PMMA	-20 °C to +70 °C	normal pressure	rubber feet

Specification:

Aluminium frame with panels made of acrylic glass, including four shelves made of polycarbonate, tray, hygrometer and desiccant, usable with up to 38 shelves, stackable.

Cat. No.:	V 1938-07
Overall dimensions* W x H x D mm	310 x 735 x 375
Usable interior space W x H x D mm	260 x 690 x 330
Capacity liters	73
Weight kg/approx.	8
Maximum all-over load per shelf kg	10
Total all-over load kg	40



BESTSELLER

SICCO Star-Desiccator Horizontal

Panels:	Material:	Temperature resistance:	Use:	Stand:
clear	PMMA	-20 °C to +70 °C	normal pressure	rubber feet

Specification:

Aluminium frame with panels made of acrylic glass, including two shelves made of polycarbonate, tray, hygrometer and desiccant, usable with up to 13 shelves, stackable, door opens forward.

Cat. No.:	V 1899-07
Overall dimensions* W x H x D mm	525 x 340 x 375
Usable interior space W x H x D mm	480 x 260 x 330
Capacity liters	51
Weight kg/approx.	7
Maximum all-over load per shelf kg	1,5
Total all-over load kg	30

Applications:

Especially suitable for wide products such as A3 sheets or conductor boards.



SICCO Maxi 1-Desiccator Horizontal

Panels: clear	Material: PMMA	Temperature resistance: -20 °C to +70 °C	Use: normal pressure	Stand: rubber feet
-------------------------	--------------------------	--	--------------------------------	------------------------------

Specification:

Aluminium frame with panels made of acrylic glass, including two shelves made of stainless steel, tray and hygrometer, usable with up to 9 shelves, stackable.

Cat. No.:	V 1835-07
Overall dimensions:* W x H x D mm	1080 x 555 x 580
Usable interior space W x H x D mm	1030 x 500 x 500
Capacity liters	311
Weight kg/approx.	29
Maximum all-over load per shelf kg	30
Total all-over load kg	160

Applications:

Especially suitable for wide products such as paper sheets. Swing-up door for easy loading. Easy placement in shelves due to low height.



SICCO Big-Star-Desiccator

Panels: clear	Material: PMMA	Temperature resistance: -20 °C to +70 °C	Use: normal pressure	Stand: rubber feet
-------------------------	--------------------------	--	--------------------------------	------------------------------

Specification:

Aluminium frame with panels made of acrylic glass, including two shelves made of stainless steel, tray and hygrometer, usable with up to 8 shelves.

Cat. No.:	V 1896-07
Overall dimensions* W x H x D mm	560 x 560 x 580
Usable interior space W x H x D mm	495 x 500 x 540
Capacity liters	156
Weight kg/approx.	18
Maximum all-over load per shelf kg	30
Total all-over load kg	80

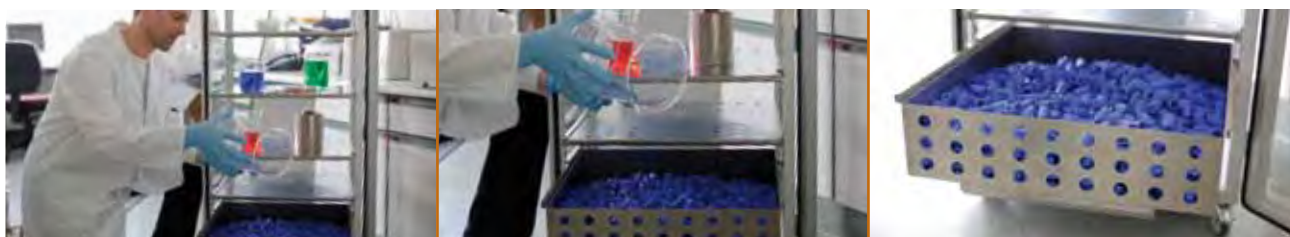

BESTSELLER**SICCO Maxi 1-Desiccator**

Panels: clear	Material: PMMA	Temperature resistance: -20 °C to +70 °C	Use: normal pressure	Stand: casters
-------------------------	--------------------------	--	--------------------------------	--------------------------

Specification:

Aluminium frame with panels made of acrylic glass, including four shelves made of stainless steel, tray and hygrometer, four casters, usable with up to 17 shelves.

Cat. No.:	V 1852-01
Overall dimensions* W x H x D mm	560 x 1150 x 580
Usable interior space W x H x D mm	495 x 1030 x 540
Capacity liters	311
Weight kg/approx.	30
Maximum all-over load per shelf kg	30
Total all-over load kg	160



15

Desiccators for drying/storage

SICCO Maxi 2-Desiccator

Panels: clear	Material: PMMA	Temperature resistance: -20 °C to +70 °C	Use: normal pressure	Stand: casters
-------------------------	--------------------------	--	--------------------------------	--------------------------

Specification:

Aluminium frame with panels made of acrylic glass, two compartments and two doors, including four shelves made of stainless steel, two trays and two hygrometers, four casters, usable with up to 8 shelves per compartment.

Cat. No.:	V 1853-01
Overall dimensions* W x H x D mm	560 x 1150 x 580
Usable interior space W x H x D mm	495 x 500 x 540 per compartment
Capacity liters	156 per compartment
Weight kg/approx.	34
Maximum all-over load per shelf kg	30
Total all-over load kg	80 per compartment

BESTSELLER

SICCO Big-Star Desiccator Low

Panels: clear	Material: PMMA	Temperature resistance: -20 °C to +70 °C	Use: normal pressure	Stand: Rubber feet
-------------------------	--------------------------	--	--------------------------------	------------------------------

Specification:

Aluminium frame with panels made of acrylic glass, including one shelf made of stainless steel, tray and hygrometer, usable with up to 5 shelves, stackable.

Cat.No.:	V 1897-07
Overall dimensions* W x H x D mm	550 x 330 x 580
Usable interior space W x H x D mm	495 x 250 x 500
Capacity liters	91
Weight kg/ approx.	13
Maximum all-over load per shelf kg	30
Total all-over load kg	80

Applications:

Especially suitable for wide products such as paper sheets. Placement in shelves due to low height. Storage of standard laboratory glass bottles up to 1000 ml possible.



SICCO Dolly Desiccator

Panels: clear	Material: PMMA	Temperature resistance: -20 °C to +70 °C	Use: normal pressure	Stand: casters
-------------------------	--------------------------	--	--------------------------------	--------------------------

Specification:

Aluminium frame with panels made of acrylic glass, work top made of aluminium, including four shelves made of stainless steel, tray and hygrometer, four casters (two of them with brakes), lateral bow-type handle, usable with up to 28 shelves.

Cat. No.:	V 1760-07
Overall dimensions* W x H x D mm	600 x 900 x 430
Usable interior space W x H x D mm	550 x 850 x 350
Capacity liters	195
Weight kg/ approx.	27
Maximum all-over load per shelf kg	30
Total all-over load kg	160

Applications:

Aluminium work top usable as storage space during setting and removal as well as enlargement of existing work space. By means of the bow-type handle and the smooth-running casters, the loaded wagon can be moved easily through pushing and pulling it. Low depth for the use in tight spaces.



Add. accessories

Page 77-86.

SICCO Star Desiccator Double

Panels:	Material:	Temperature resistance:	Use:	Stand:
clear	PMMA	-20 °C to +70 °C	normal pressure	Rubber feet

Specification:

Aluminium frame with panels made of stainless steel and double door, including four shelves made of stainless steel, hygrometer and desiccant, usable with up to 26 shelves, stackable.

NEW

Cat.No.:	V 1930-07
Overall dimensions* W x H x D mm	630 x 520 x 375
Usable interior space W x H x D mm	570 x 480 x 330
Capacity liters	106
Weight kg/ approx.	13
Maximum all-over load per shelf kg	10
Total all-over load kg	30

Applications:

Especially suitable for wide products such as A3 sheets or conductor boards. The doors can be easily opened right- and left-hand-sided, for easy loading and unloading. The bar on the left door serves as stopper for the door sealing.



SICCO Star-Thermo-Desiccator

Panels: clear	Material: PMMA/Glass	Temperature resistance: -20 °C to +70 °C	Use: normal pressure	Stand: rubber feet
-------------------------	--------------------------------	--	--------------------------------	------------------------------

Specification:

Aluminium frame with 2-pane-insulation (inside glass, outside acrylic glass), including four shelves made of acrylic glass, usable with up to 26 shelves. Integrated heating (850 W) with temperature sensor and air circulation. Electrical power connection 230 V / 50 Hz is required.



Cat.-No.:	V 1830-07
Overall dimensions* <small>W x H x D mm</small>	310 x 630 x 420
Usable interior space <small>W x H x D mm</small>	260 x 480 x 330
Addi. place requirement for heating <small>mm</small>	80 back side
Capacity <small>liters</small>	55
Weight <small>kg, approx.</small>	16
Maximum all-over load per shelf <small>kg</small>	2,5
Maximum all-over load <small>kg</small>	10
Temperature Setting	Room temperature plus 5 °C up to max. + 60 °C
Setting accuracy	1 °C
Deviation of temperature	approx. +/- 1,75 °C at 40 °C
Heating system	air circulation
Power consumption	850 W
Power connection	230 V / 50 Hz

Applications:

Ideal for warming of samples and substances in order to reduce reaction times or for temporary storage at constant ambient temperature.

The SICCO Heating with Air Circulation – how it works:

The fan on the back side sucks in the air inside the desiccator and blows it over the heating spiral. At the same time, the warmed air flows back into the desiccator. This air circulation provides an even heating of the interior space.

The temperature sensor inside monitors continuously the actual temperature. Once the temperature has reached the set value, the heating is switched off. The fan keeps on working for providing best heat distribution.

As soon as the internal temperature drops 2 °C below the set value, the heating is switched on again automatically.

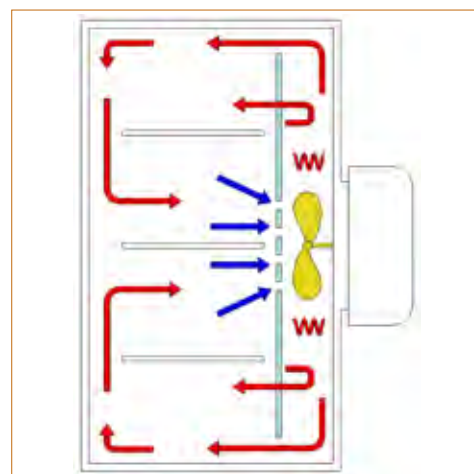

BESTSELLER

SICCO Mini-Desiccators Basic

Panels: **clear** Material: **Polycarbonate** Temperature resistance: **-35 °C to +70 °C** Use: **normal pressure**

Version Mini 1:
Polycarbonate, one compartment, including desiccant, stackable.

A	Cat. No.:	V 1850-01
	Overall dimensions W x H x D mm	221 x 183 x 214
	Usable interior space W x H x D mm	212 x 162 x 180
	Capacity liters	6,2
	Weight kg	0,9
	Total all-over load kg	3

Version Mini 2:
Polycarbonate, two permanently fixed compartments, including desiccant, stackable.

B	Cat. No.:	V 1850-02
	Overall dimensions W x H x D mm	221 x 362 x 214
	Usable interior space W x H x D mm	212 x 162 x 180 per compartment
	Capacity liters	6,2 per compartment
	Weight kg	1,8
	Total all-over load kg	3 per compartment

Version Mini 3:
Polycarbonate, three permanently fixed compartments, including desiccant, stackable.

C	Cat. No.:	V 1850-03
	Overall dimensions W x H x D mm	221 x 540 x 214
	Usable interior space W x H x D mm	212 x 162 x 180 per compartment
	Capacity liters	6,2 per compartment
	Weight kg	2,7
	Total all-over load kg	3 per compartment



Do you already know:
Mini Vitrum Desiccator made of borosilicate glass Page 29

Drying properties

Please read our information on pages 88-95.



SICCO Mini-Desiccators Premium

Panels: **clear** Material: **Polycarbonate** Temperature resistance: **-35 °C to +70 °C** Use: **normal pressure**

Version Mini 1:

Polycarbonate, one compartment, including two shelves, hygrometer and desiccant, non-slip rubber feet, stackable.

A	Cat. No.:	V 1950-01
	Overall dimensions W x H x D mm	221 x 183 x 214
	Usable interior space W x H x D mm	212 x 162 x 180
	Capacity liters	6,2
	Weight kg	0,9
	Maximum all-over load per shelf kg	2
	Total all-over load kg	3

Version Mini 2:

Polycarbonate, two permanently fixed compartments, including four shelves, two hygrometers and desiccant, non-slip rubber feet, stackable.

B	Cat. No.:	V 1950-02
	Overall dimensions W x H x D mm	221 x 362 x 214
	Usable interior space W x H x D mm	212 x 162 x 180 per compartment
	Capacity liters	6,2 per compartment
	Weight kg	1,8
	Maximum all-over load per shelf kg	2
	Total all-over load kg	3 per compartment

Version Mini 3:

Polycarbonate, three permanently fixed compartments, including six shelves, three hygrometers and desiccant, non-slip rubber feet, stackable.

C	Cat. No.:	V 1950-03
	Overall dimensions W x H x D mm	221 x 540 x 214
	Usable interior space W x H x D mm	212 x 162 x 180 per compartment
	Capacity liters	6,2 per compartment
	Weight kg	2,7
	Maximum all-over load per shelf kg	2
	Total all-over load kg	3 per compartment



SICCO Mini-Desiccator Secure Box Basic

Panels:	Material:	Temperature resistance:	Use:
clear	Polycarbonate	-35 °C to +70 °C	normal pressure

Specification:

Polycarbonate, lockable, including desiccant, stackable.

Cat. No.:	V 1847-06
Overall dimensions W x H x D mm	221 x 183 x 214
Usable interior space W x H x D mm	212 x 162 x 180
Capacity liters	6,2
Weight kg	0,9
Total all-over load kg	3

Applications:

Safe storage of consumables, very handy.

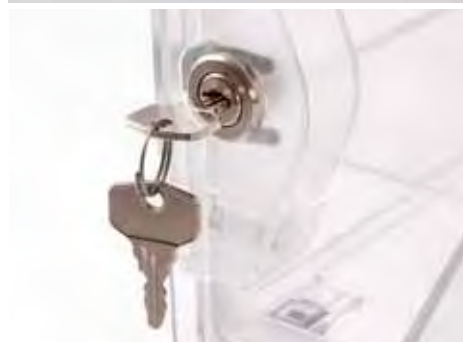

SICCO Mini-Desiccator Secure Box Premium

Panels:	Material:	Temperature resistance:	Use:
clear	Polycarbonate	-35 °C to +70 °C	normal pressure

Specification:

Polycarbonate, lockable, including two shelves, hygrometer and desiccant, non-slip rubber feet, stackable.

Cat. No.:	V 1947-06
Overall dimensions W x H x D mm	221 x 183 x 214
Usable interior space W x H x D mm	212 x 162 x 180
Capacity liters	6,2
Weight kg	0,9
Maximum all-over load per shelf kg	2
Total all-over load kg	3

Applications:

Safe storage of consumables, very handy.

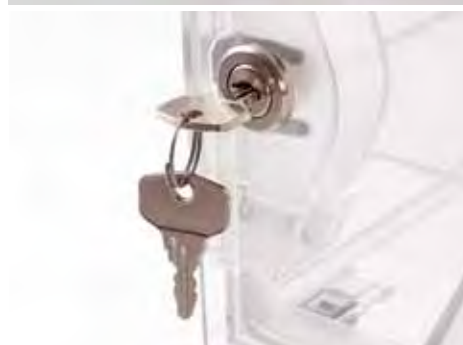

Drying properties

Please read our information on pages 88-95.



SICCO Mini-Mobile-Desiccator Basic

Panels:	Material:	Temperature resistance:	Use:
clear	Polycarbonate	-35 °C to +70 °C	normal pressure

Specification:

Polycarbonate, with practical handle, including desiccant.

Cat. No.:	V 1848-06
Overall dimensions W x H x D mm	221 x 183 x 214
Usable interior space W x H x D mm	212 x 162 x 180
Capacity liters	6,2
Weight kg	1,0
Total all-over load kg	3



SICCO Mini-Mobile-Desiccator Premium

Panels:	Material:	Temperature resistance:	Use:
clear	Polycarbonate	-35 °C to +70 °C	normal pressure

Specification:

Polycarbonate, with practical handle, including two shelves, hygrometer and desiccant, non-slip rubber feet.

Cat. No.:	V 1948-06
Overall dimensions W x H x D mm	221 x 183 x 214
Usable interior space W x H x D mm	212 x 162 x 180
Capacity liters	6,2
Weight kg	1,0
Maximum all-over load per shelf kg	2
Total all-over load kg	3

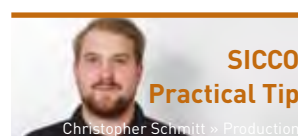

SICCO Practical Tip

You are looking for a light-weight desiccator?

Our Mini-Desiccators have tight dimensions and can be easily transported due to their light weight.



Add. accessories

Page 77-86.

*Overall dimensions are indicated as follows: width including hinge, height starting from base, depth without handle



Also made by BOHLENDER

Professional High-Performance Fluoroplastic Labware

Stirrer shafts, Magnetic stirring bars, Distributors for bottles or Tubes – these are just a few innovative BOLA products made of professional high-performance materials such as PTFE, PFA and FEP. For fast and safe working in your laboratory.



Ask for our catalogue
free of charge.

- » More than 250 pages with professional high-performance labware and tips of our experts
- » Great selection and helpful service from BOHLENDER - as always

Info-Hotline:

+49 (0) 93 46-92 86 0

www.bola.de



Desiccator Wall
for drying and
storage

- » spacious
- » mobile
- » functional



SICCO Desiccator Wall

Panels: clear	Material: PMMA	Temperature resistance: -20 °C to +70 °C	Use: normal pressure	Stand: casters
-------------------------	--------------------------	--	--------------------------------	--------------------------

Specification:

Aluminium frame with panels made of acrylic glass, six compartments and six doors, including six shelves made of stainless steel, six trays and six hygrometers, four casters, usable with up to 8 shelves per compartment.

Cat. No.:	V 1994-08
Overall dimensions* W x H x D mm	1080 x 1870 x 580
Usable interior space W x H x D mm	495 x 500 x 540 per compartment
Capacity liters	156 per compartment
Weight kg, approx	100
Maximum all-over load per shelf kg	30
Maximum all-over load kg	80 per compartment
Total all-over load kg	200
Ground clearance of lowest chamber mm	240





SICCO
Practical Tip

Uwe Hossfeld » Technical department

What is done if humidity does not decrease?

Check if the door closes tightly or if the sealing is damaged. Regenerate your desiccant or increase its portion. Check if the hygrometer is working correctly.

page 99-100



Vitrum BENEFITS

- » reinforced aluminium frame with heat-resistant borosilicate glass panels
- » door with magnetic catch and circular rubber seal
- » for storing hot materials (up to max. 300 °C)
- » very good chemical resistance against aggressive products
- » variable height shelves made of stainless steel
- » easy to read electronic hygrometer
- » telescopic shelves



BESTSELLER

SICCO Star-Vitrum-Desiccator

Panels:	Material:	Temperature resistance:	Use:	Stand:
clear	borosilicate 3.3	-70 °C to +150 °C	normal pressure	rubber feet

Specification:

Aluminium frame with panels made of heat-resistant borosilicate glass 3.3, including four shelves made of stainless steel, tray, hygrometer and desiccant, usable with up to 26 shelves, stackable.

Cat. No.:	V 1841-07
Overall dimensions* W x H x D mm	310 x 525 x 375
Usable interior space W x H x D mm	260 x 480 x 330
Capacity liters	51
Weight kg/approx.	14
Maximum all-over load per shelf kg	10
Total all-over load kg	30

Applications:

Especially suitable for storing hot materials (max. 300°C), very good resistance compared to most acids and organic substances.



Add. accessories

Page 77-86.

SICCO Star-Vitrum-Desiccator Horizontal

Panels: clear	Material: borosilicate 3.3	Temperature resistance: -70 °C to +150 °C	Use: normal pressure	Stand: rubber feet
------------------	-------------------------------	--	-------------------------	-----------------------

Specification:

Aluminium frame with panels made of heat-resistant borosilicate glass 3.3, including two shelves made of aluminium, tray, hygrometer and desiccant, usable with up to 13 shelves, stackable, door opens forward.

NEW

Cat. No.:	V 1821-07
Overall dimensions* W x H x D mm	525 x 340 x 375
Usable interior space W x H x D mm	480 x 260 x 330
Capacity liters	51
Weight kg/approx.	12
Maximum all-over load per shelf kg	10
Total all-over load kg	30

Applications:

Especially suitable for storing hot materials (max. 300°C), very good resistance compared to most acids and organic substances.



Stable Desiccators

»» Because of the aluminium frame and fiber-glass reinforced corner connections, the SICCO Desiccators are specially stable but also lightweight which is ideal for our application. ««

Staff Member Forensic Unit

SICCO Big-Star-Vitrum Desiccator

Panels: clear	Material: borosilicate 3.3	Temperature resistance: -70 °C to +150 °C	Use: normal pressure	Stand: rubber feet
------------------	-------------------------------	--	-------------------------	-----------------------

Specification:

Aluminium frame with panels made of heat-resistant borosilicate glass 3.3, including two shelves made of stainless steel, tray and hygrometer, usable with up to 17 shelves.

Cat. No.:	V 1844-07
Overall dimensions* W x H x D mm	560 x 560 x 580
Usable interior space W x H x D mm	495 x 500 x 540
Capacity liters	156
Weight kg/approx.	22
Maximum all-over load per shelf kg	30
Total all-over load kg	80



Drying properties

Please read our information on pages 88-95.



SICCO Maxi 1-Vitrum-Desiccator

Panels:	Material:	Temperature resistance:	Use:	Stand:
clear	borosilicate 3.3	-70 °C to +150 °C	normal pressure	casters

Specification:

Aluminium frame with panels made of heat-resistant borosilicate glass 3.3, including four shelves made of stainless steel, tray and hygrometer, four casters, usable with up to 34 shelves.

Cat. No.:	V 1846-07
Overall dimensions* W x H x D mm	560 x 1150 x 580
Usable interior space W x H x D mm	495 x 1030 x 540
Capacity liters	311
Weight kg/approx.	37
Maximum all-over load per shelf kg	30
Total all-over load kg	160



SICCO Maxi 2-Vitrum-Desiccator

Panels:	Material:	Temperature resistance:	Use:	Stand:
clear	borosilicate 3.3	-70 °C to +150 °C	normal pressure	casters

Specification:

Aluminium frame with panels made of heat-resistant borosilicate glass 3.3, two compartments and two doors, including four shelves made of stainless steel, two trays and two hygrometers, four casters, usable with up to 17 shelves per compartment.

Cat. No.:	V 1845-07
Overall dimensions* W x H x D mm	560 x 1150 x 580
Usable interior space W x H x D mm	495 x 500 x 540 per compartment
Capacity liters	156 per compartment
Weight kg/approx.	42
Maximum all-over load per shelf kg	30
Total all-over load kg	80 per compartment

Applications:

Especially suitable for storing hot materials (max. 300°C), very good resistance compared to most acids and organic substances.



Add. accessories

Page 77-86.

*Overall dimensions are indicated as follows: width including hinge, height starting from base, depth without handle

SICCO Mini-Vitrum Desiccator

Panels:	Material:	Temperature resistance:	Use:	Stand:
clear	borosilicate 3.3	-70 °C to +120 °C	normal pressure	rubber feet

Specification:

Aluminium frame with panels made of heat-resistant borosilicate glass 3.3, including one shelf made of aluminium, hygrometer and desiccant, usable with up to one shelf, stackable.

NEW

Cat. No.:	V 1811-07
Overall dimensions* W x H x D mm	220 x 183 x 214
Usable interior space W x H x D mm	200 x 170 x 180
Capacity liters	6
Weight kg/approx.	2
Maximum all-over load per shelf kg	2
Total all-over load kg	3

Applications:

Especially suitable for storing hot materials (max. 300 °C), very good resistance compared to most acids and organic substances.





SICCO offers custom manufacture.

Every lab is different. By offering an extensive range of established and sophisticated standard solutions we take into account the varied requirements of the respective branches and sectors.

But maybe you are looking for something special? Something that is not included in our standard product range?

In that case we are able to offer an individual custom manufacture. This is easier and faster than you may expect. Discuss your idea with our professionals. They will give advise and support during design. Finally, your idea will become real: We produce as per your requirements and in compliance with the chosen raw materials – already from 1 piece.

We only need a drawing (a sketch is sufficient) and some further information.

» **You have a special request?**

Give us a call: +49 (0) 93 46-92 86-0.

SICCO BENEFITS

- » orange panels reduce light incidence
- » for storage of light-sensitive substances
- » door with magnetic catch and circular rubber seal
- » variable height shelves
- » easy to read electronic hygrometer
- » telescopic shelves

SICCO Star-Desiccator Protect

Panels:	Material:	Temperature resistance:	Use:	Stand:
orange	PMMA	-20 °C to +70 °C	normal pressure	rubber feet

Specification:

Aluminium frame, orange panels made of acrylic glass reduce light incidence and protect against ultraviolet radiation, including four shelves made of polycarbonate, tray, hygrometer and desiccant, usable with up to 26 shelves, stackable.

Cat. No.:	V 1879-07
Overall dimensions* W x H x D mm	310 x 525 x 375
Usable interior space W x H x D mm	260 x 480 x 330
Capacity liters	51
Weight kg/approx.	7
Maximum all-over load per shelf kg	10
Total all-over load kg	30

Applications:

Especially suitable for the storage of light-sensitive substances.



« »
Special Request?
+49 (0) 93 46 92 86-0

Drying properties

Please read our information on pages 88-95.



SICCO Big-Star-Desiccator Protect

Panels: orange	Material: PMMA	Temperature resistance: -20 °C to +70 °C	Use: normal pressure	Stand: rubber feet
--------------------------	--------------------------	--	--------------------------------	------------------------------

Specification:

Aluminium frame, orange panels made of acrylic glass reduce light incidence and protect against ultraviolet radiation, including two shelves made of stainless steel, tray and hygrometer, usable with up to 8 shelves.

Cat. No.:	V 1926-07
Overall dimensions* W x H x D mm	560 x 560 x 580
Usable interior space W x H x D mm	495 x 500 x 540
Capacity liters	156
Weight kg/approx.	18
Maximum all-over load per shelf kg	30
Total all-over load kg	80



SICCO INNOVATION

Suspension arrangements and Rails

The rail system of the Star Desiccators is equipped with a consecutive numeration for an easy and fast positioning of the shelves.

page 97

SICCO Maxi 1-Desiccator Protect

Panels: orange	Material: PMMA	Temperature resistance: -20 °C to +70 °C	Use: normal pressure	Stand: casters
--------------------------	--------------------------	--	--------------------------------	--------------------------

Specification:

Aluminium frame, orange panels made of acrylic glass reduce light incidence and protect against ultraviolet radiation, including four shelves made of stainless steel, tray and hygrometer, four casters, usable with up to 17 shelves.

Cat. No.:	V 1927-07
Overall dimensions* W x H x D mm	560 x 1150 x 580
Usable interior space W x H x D mm	495 x 1030 x 540
Capacity liters	311
Weight kg/approx.	30
Maximum all-over load per shelf kg	30
Total all-over load kg	160

Applications:

Especially suitable for the storage of light-sensitive substances.



Add. accessories

Page 77-86.

*Overall dimensions are indicated as follows: width including hinge, height starting from base, depth without handle

BESTSELLER

SICCO Maxi 2-Desiccator Protect

Panels:	Material:	Temperature resistance:	Use:	Stand:
orange	PMMA	-20 °C to +70 °C	normal pressure	casters

Specification:

Aluminium frame, orange panels made of acrylic glass reduce light incidence and protect against ultraviolet radiation, two compartments and two doors, including four shelves made of stainless steel, two trays and two hygrometers, four casters, usable with up to 8 shelves per compartment.

Cat. No.:	V 1928-07
Overall dimensions* W x H x D mm	560 x 1150 x 580
Usable interior space W x H x D mm	495 x 500 x 540 per compartment
Capacity liters	156 per compartment
Weight kg/approx.	34
Maximum all-over load per shelf kg	30
Total all-over load kg	80 per compartment



33

Desiccators for drying/storage

**Light-protected storage**

» Due to their orange panels, the Desiccators Protect are perfectly suitable for the storage of UV sensitive electronic components such as light-sensitive resistors.

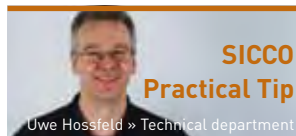

Electro chemist

**SICCO Practical Tip**

Uwe Hossfeld » Technical department

What is done if humidity does not decrease?

Check if the door closes tightly or if the sealing is damaged. Regenerate your desiccant or increase its portion. Check if the hygrometer is working correctly.

page 99-100

SICCO Mini-Desiccator Protect Basic

Panels:	Material:	Temperature resistance:	Use:
orange	Polycarbonate	-35 °C to +70 °C	normal pressure

Specification:

Orange polycarbonate reduces light incidence and protects against ultraviolet radiation, including desiccant, stackable.

Cat. No.:	V 1842-06
Overall dimensions W x H x D mm	221 x 183 x 214
Usable interior space W x H x D mm	212 x 162 x 180
Capacity liters	6,2
Weight kg	0,9
Total all-over load kg	3

**Drying properties**

Please read our information on pages 88-95.



SICCO Mini-Desiccator Protect Premium

Panels: orange	Material: Polycarbonate	Temperature resistance: -35 °C to +70 °C	Use: normal pressure
--------------------------	-----------------------------------	--	--------------------------------

Specification:

Orange polycarbonate reduces light incidence and protects against ultra-violet radiation, including two shelves, hygrometer and desiccant, non-slip rubber feet, stackable.

Cat. No.:	V 1942-06
Overall dimensions W x H x D mm	221 x 183 x 214
Usable interior space W x H x D mm	212 x 162 x 180
Capacity liters	6,2
Weight kg	0,9
Maximum all-over load per shelf kg	2
Total all-over load kg	3



SICCO INNOVATION

Mini-Desiccators

Because of the injection molding production, different materials can be used. So the Mini-Desiccators are specially versatile.



Add. accessories

Page 77-86.

*Overall dimensions are indicated as follows: width including hinge, height starting from base, depth without handle

SICCO BENEFITS

- » black, absolutely lightproof panels
- » for storage of light-sensitive substances
- » door with magnetic catch and circular rubber seal
- » variable height shelves
- » easy to read electronic hygrometer
- » telescopic shelves



SICCO Star-Desiccator Black

Panels: black	Material: PMMA	Temperature resistance: -20 °C to +70 °C	Use: normal pressure	Stand: rubber feet
-------------------------	--------------------------	--	--------------------------------	------------------------------

Specification:

Aluminium frame, panels made of black acrylic glass prevent light incidence and protect against ultraviolet radiation, high-gloss surfaces, including four shelves made of polycarbonate, tray, hygrometer and desiccant, usable with up to 26 shelves, stackable.

Cat. No.:	V 1891-07
Overall dimensions* W x H x D mm	310 x 525 x 375
Usable interior space W x H x D mm	260 x 480 x 330
Capacity liters	51
Weight kg/approx.	7
Maximum all-over load per shelf kg	10
Total all-over load kg	30

Applications:

Especially for the storage of substances to the exclusion of light transmission and ultraviolet radiation.



Drying properties

Please read our information on pages 88-95.



SICCO Big-Star-Desiccator Black

Panels: black	Material: PMMA	Temperature resistance: -20 °C to +70 °C	Use: normal pressure	Stand: rubber feet
-------------------------	--------------------------	--	--------------------------------	------------------------------

Specification:

Aluminium frame, panels made of black acrylic glass prevent light incidence and protect against ultraviolet radiation, high-gloss surfaces, including two shelves made of stainless steel, tray and hygrometer, usable with up to 8 shelves.

Cat. No.:	V 1939-07
Overall dimensions* W x H x D mm	560 x 560 x 580
Usable interior space W x H x D mm	495 x 500 x 540
Capacity liters	156
Weight kg/approx.	18
Maximum all-over load per shelf kg	30
Total all-over load kg	80



SICCO Maxi 1-Desiccator Black

Panels: black	Material: PMMA	Temperature resistance: -20 °C to +70 °C	Use: normal pressure	Stand: casters
-------------------------	--------------------------	--	--------------------------------	--------------------------

Specification:

Aluminium frame, panels made of black acrylic glass prevent light incidence and protect against ultraviolet radiation, high-gloss surfaces, including four shelves made of stainless steel, tray and hygrometer, four casters, usable with up to 17 shelves.

Cat. No.:	V 1936-07
Overall dimensions* W x H x D mm	560 x 1150 x 580
Usable interior space W x H x D mm	495 x 1030 x 540
Capacity liters	311
Weight kg/approx.	30
Maximum all-over load per shelf kg	30
Total all-over load kg	160



Add. accessories

Page 77-86.

*Overall dimensions are indicated as follows: width including hinge, height starting from base, depth without handle

SICCO Maxi 2-Desiccator Black

Panels: black	Material: PMMA	Temperature resistance: -20 °C to +70 °C	Use: normal pressure	Stand: casters
-------------------------	--------------------------	--	--------------------------------	--------------------------

Specification:

Aluminium frame, panels made of black acrylic glass prevent light incidence and protect against ultraviolet radiation, high-gloss surfaces, two compartments and two doors, including four shelves made of stainless steel, two trays and two hygrometers, four casters, usable with up to 8 shelves per compartment.

Cat. No.:	V 1937-07
Overall dimensions* W x H x D mm	560 x 1150 x 580
Usable interior space W x H x D mm	495 x 500 x 540 per compartment
Capacity liters	156 per compartment
Weight kg/approx.	34
Maximum all-over load per shelf kg	30
Total all-over load kg	80 per compartment





SICCO
Practical Tip

Martin Haag » Assembly

How can you regenerate Silicagel?

Just put the tray with the desiccant for 90 minutes at 90-100° C in the oven. Attention: A microwave is unsuitable for this process.

page 99

Drying properties

Please read our information on pages 88-95.



SICCO Mini-Desiccator Black Basic

Panels:	Material:	Temperature resistance:	Use:
black	Polycarbonate	-35 °C to +70 °C	normal pressure

Specification:

Black polycarbonate prevents light incidence and protects against ultraviolet radiation, including desiccant, stackable.

Cat. No.:	V 1840-06
Overall dimensions W x H x D mm	221 x 183 x 214
Usable interior space W x H x D mm	212 x 162 x 180
Capacity liters	6,2
Weight kg	0,9
Total all-over load kg	3



SICCO Mini-Desiccator Black Premium

Panels:	Material:	Temperature resistance:	Use:
black	Polycarbonate	-35 °C to +70 °C	normal pressure

Specification:

Black polycarbonate prevents light incidence and protects against ultraviolet radiation, including two shelves, hygrometer and desiccant, non-slip rubber feet, stackable.

Cat. No.:	V 1940-06
Overall dimensions W x H x D mm	221 x 183 x 214
Usable interior space W x H x D mm	212 x 162 x 180
Capacity liters	6,2
Weight kg	0,9
Maximum all-over load per shelf kg	2
Total all-over load kg	3



SICCO Desiccators for gas-filling

SICCO Desiccators for gas-filling provide ideal conditions for safe and secure storage of poisonous chemicals. Rare or inert gases like nitrogen can be

introduced as soon as the door is closed tightly. Compared to the ambient air, the inert gas does not react with the stored substances.

Feature Summary

- » Two connections for gas-filling including quick couplings with self-sealing valves and hose
- » Non-slip rubber feet or four casters (two of the casters with brakes)
- » Extra large electronic hygrometer
- » Reinforced aluminium frame with acrylic or borosilicate glass panels
- » Door with magnetic catch, circular rubber seal, the Super-Star-Desiccator includes a cylinder lock
- » Variable height shelves made of polycarbonate, stainless steel or aluminium
- » Telescopic shelves

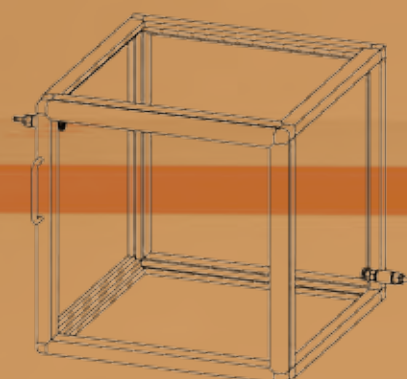

SICCO BENEFITS

- » reinforced aluminium frame with acrylic panels
- » door with magnetic catch, circular rubber seal and cylinder lock
- » easy to read electronic hygrometer
- » variable height shelves
- » connections for gas-filling including quick couplings with self-sealing valves and hose
- » telescopic shelves



SICCO Super-Star-Desiccator

Panels:	Material:	Temperature resistance:	Use:	Stand:
clear	PMMA	-20 °C to +70 °C	normal pressure	rubber feet

Specification:

Aluminium frame with panels made of acrylic glass, including four shelves made of polycarbonate, tray, hygrometer, desiccant, cylinder lock and hose (5 m) with two quick couplings for gas-filling, usable with up to 26 shelves, stackable.

Cat. No.:	V 1875-07
Overall dimensions* W x H x D mm	310 x 525 x 375
Addi. place requirement for coupling mm	150 per panel
Usable interior space W x H x D mm	260 x 480 x 330
Capacity liters	51
Weight kg/approx.	7
Maximum all-over load per shelf kg	10
Total all-over load kg	30
Bore diameter of quick coupling mm	Ø 6
Bore diameter in panels mm	Ø 16,5 – <small>upper left front side lower right back side</small>



BESTSELLER



SICCO Practical Tip
Uwe Hossfeld » Technical department

You would like to flush your desiccator with gas in a controlled way?
Using the SICCO Gas Dosing Controller, the gas inlet is automatically regulated in dependence of the inside relative humidity.

page 102



Add. accessories
Page 77-86.

*Overall dimensions are indicated as follows: width including hinge, height starting from base, depth without handle

SICCO Super-Star-Desiccator Vitrum

Panels:	Material:	Temperature resistance:	Use:	Stand:
clear	borosilicate 3.3	-20 °C to +150 °C	normal pressure	rubber feet

Specification:

Aluminium frame with panels made of heat-resistant borosilicate glass 3.3, including four shelves made of stainless steel, tray, hygrometer, desiccant, cylinder lock and hose (5 m) with two quick couplings for gas-filling, usable with up to 26 shelves, stackable.

Cat. No.:	V 1825-07
Overall dimensions* W x H x D mm	310 x 525 x 375
Addi. place requirement for coupling mm	150 per panel
Usable interior space W x H x D mm	260 x 480 x 330
Capacity liters	51
Weight kg/approx.	15
Maximum all-over load per shelf kg	10
Total all-over load kg	30
Bore diameter of quick coupling mm	Ø 6
Bore diameter in panels mm	Ø 16,5 – <small>upper left front side lower right back side</small>

Applications:

The workspace is made of materials with good chemical resistance (aluminium, stainless steel, borosilicate glass) for storage of aggressive products.

« Special Request? »
+49 (0) 93 46 92 86-0

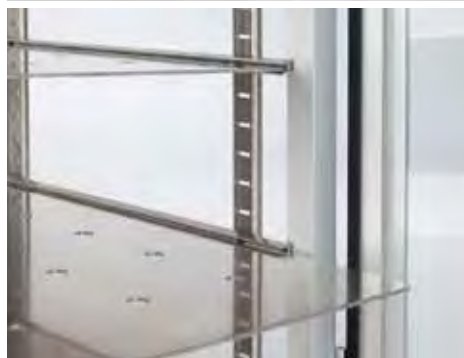

Desiccators for gas-filling

» We use SICCO Desiccators for the storage of electronic components until further treatment in order to protect them from dust and humidity. Through purging the interior with nitrogen, a real dry atmosphere is created which avoids damages through oxidisations. «

Quality Agent Electronic Production



SICCO Practical Tip
Benjamin Schmitt
» Technical department

Where is the best position for Silicagel?

Just place your components directly next to the Silicagel where humidity is absorbed most quickly.

page 99

Drying properties

Please read our information on pages 88-95.



SICCO Super-Big-Star-Desiccator

Panels:	Material:	Temperature resistance:	Use:	Stand:
clear	PMMA	-20 °C to +70 °C	normal pressure	rubber feet

Specification:

Aluminium frame with panels made of acrylic glass, including two shelves made of stainless steel, tray, hygrometer and hose (5 m) with two quick couplings for gas-filling, usable with up to 8 shelves.

Cat. No.:	V 1935-07
Overall dimensions* W x H x D mm	560 x 560 x 580
Addi. place requirement for coupling mm	150 per panel
Usable interior space W x H x D mm	495 x 500 x 540
Capacity liters	156
Weight kg/approx.	18
Maximum all-over load per shelf kg	30
Total all-over load kg	80
Bore diameter of quick coupling mm	Ø 6
Bore diameter in panels mm	Ø 16,5 – upper left front side lower right back side



SICCO Super-Maxi 1-Desiccator

Panels:	Material:	Temperature resistance:	Use:	Stand:
clear	PMMA	-20 °C to +70 °C	normal pressure	casters

Specification:

Aluminium frame with panels made of acrylic glass, including four shelves made of stainless steel, tray, hygrometer and hose (5 m) with two quick couplings for gas-filling, four casters, usable with up to 17 shelves.

Cat. No.:	V 1932-01
Overall dimensions* W x H x D mm	560 x 1150 x 580
Addi. place requirement for coupling mm	150 per panel
Usable interior space W x H x D mm	495 x 1030 x 540
Capacity liters	311
Weight kg/approx.	30
Maximum all-over load per shelf kg	30
Total all-over load kg	160
Bore diameter of quick coupling mm	Ø 6
Bore diameter in panels mm	Ø 16,5 – upper left front side lower right back side



Add. accessories

Page 77-86.

*Overall dimensions are indicated as follows: width including hinge, height starting from base, depth without handle

SICCO Super-Maxi 2-Desiccator

Panels: clear	Material: PMMA	Temperature resistance: -20 °C to +70 °C	Use: normal pressure	Stand: casters
-------------------------	--------------------------	--	--------------------------------	--------------------------

Specification:

Aluminium frame with panels made of acrylic glass, two compartments and two doors, including four shelves made of stainless steel, two trays, two hygrometers and hose (2x 5 m) with four quick couplings for gas-filling, four casters, usable with up to 8 shelves per compartment.

Cat. No.:	V 1933-01
Overall dimensions* W x H x D mm	560 x 1150 x 580
Addi. place requirement for coupling mm	150 per panel
Usable interior space W x H x D mm	495 x 500 x 540 per compartment
Capacity liters	156 per compartment
Weight kg/approx.	34
Maximum all-over load per shelf kg	30
Total all-over load kg	80 per compartment
Bore diameter of quick coupling mm	Ø 6 per compartment
Bore diameter in panels mm	Ø 16,5 – <small>upper left front side lower right back side</small>





SICCO
Practical Tip

Uwe Hossfeld » Technical department

Fast drying without nitrogen

By supplying pre-dried air from your compressed air system into the SICCO Desiccator for gas-filling, you can dry your products fast and favorably.



SICCO Mini-Desiccator for Gas-Filling Basic

Panels:	Material:	Temperature resistance:	Use:
clear	Polycarbonate	-35 °C to +70 °C	normal pressure

Specification:

Polycarbonate, including desiccant and hose (5 m) with two quick couplings for gas-filling, stackable.

Cat. No.:	V 1849-06
Overall dimensions W x H x D mm	221 x 183 x 214
Addi. place requirement for coupling mm	150
Usable interior space W x H x D mm	212 x 162 x 180
Capacity liters	6,2
Weight kg	0,9
Total all-over load kg	3



SICCO Mini-Desiccator for Gas-Filling Premium

Panels:	Material:	Temperature resistance:	Use:
clear	Polycarbonate	-35 °C to +70 °C	normal pressure

Specification:

Polycarbonate, including two shelves, hygrometer, desiccant and hose (5 m) with two quick couplings for gas-filling, non-slip rubber feet, stackable.

Cat. No.:	V 1949-06
Overall dimensions W x H x D mm	221 x 183 x 214
Addi. place requirement for coupling mm	150
Usable interior space W x H x D mm	212 x 162 x 180
Capacity liters	6,2
Weight kg	0,9
Maximum all-over load per shelf kg	2
Total all-over load kg	3



Add. accessories

Page 77-86.

*Overall dimensions are indicated as follows: width including hinge, height starting from base, depth without handle

SICCO Automatic-Desiccators

With automatic drying that can maintain a constant humidity of between 20% and 30%, SICCO Automatic-Desiccators are suitable for long-term storage. Even frequent opening of the door is compensated

automatically. They are the ideal solution for storing reference samples, electronics, photo equipment, papers, valuable cultural assets and much more.

Feature Summary

- » Automatic drying (manual regeneration of desiccant is not necessary)
- » Constant low interior humidity between 20% and 30%
- » Reinforced aluminium frame with acrylic or borosilicate glass panels
- » Easy to read electronic hygrometer
- » Non-slip rubber feet or four casters (two of the casters with brakes)
- » Variable height shelves made of polycarbonate, stainless steel or aluminium
- » Door with magnetic catch and circular rubber seal
- » Telescopic shelves

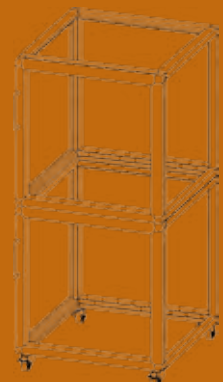

SICCO Electronic Dehumidification System -

How it works:

The essential components of the drying unit are dustless, colour-changing desiccant beads and two fans.

The automatic dehumidification and desiccant regeneration cycle operates continuously every 20 minutes as follows:

The circulating fan draws for 14 minutes interior chamber air across the desiccant and thus dehumidifies the chamber. During this phase, the one-way flap valves are open to the interior of the desiccator and closed to the exterior.

Afterwards the circulating fan is stopped and the desiccant is heated electronically to initiate its regeneration. After one minute, the regeneration fan starts to operate and draws air in an opposite direction to the first fan. Due to the air flow, the one-way flap valves to the interior of the chamber are closed and the valves to the exterior environment are open. The desiccant is heated for another four minutes to release the captured moisture to the ambient air.

At the end of the cycle, the circulating fan operates for one minute with ambient air to cool down the desiccant to the ambient temperature. Then the cycle starts again.

Drying Cycle

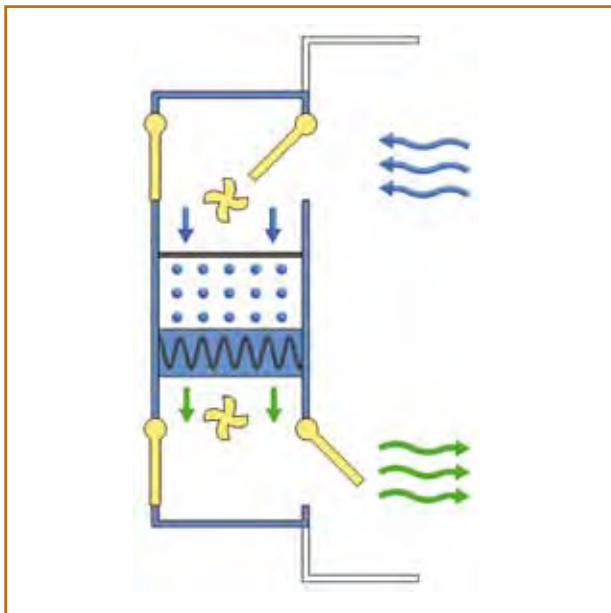

Regeneration Cycle

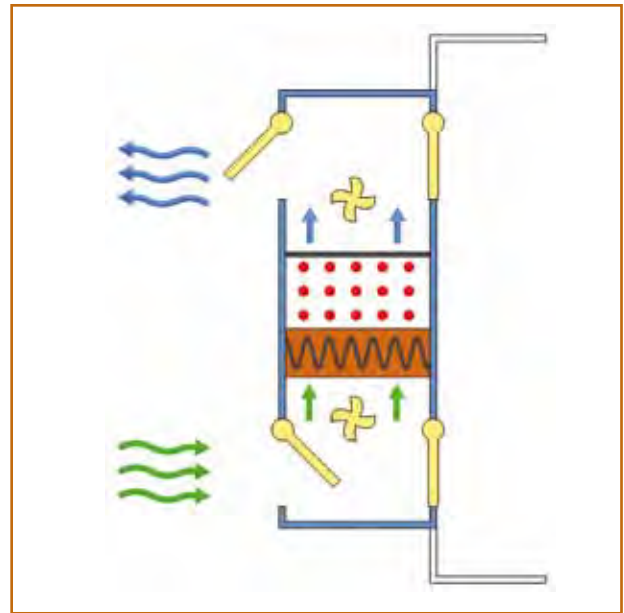

Add. accessories

Page 77-86.

BESTSELLER

SICCO Auto-Star-Desiccator

Panels:	Material:	Temperature resistance:	Use:	Stand:
clear	PMMA	-20 °C to +70 °C	normal pressure	rubber feet

Specification:

Aluminium frame with panels made of acrylic glass, rear panel made of aluminium, including four shelves made of polycarbonate, hygrometer and mounted drying unit, usable with up to 26 shelves, stackable. Electrical power connection 230 V / 50 Hz is required.



Cat. No.:	V 1877-07
Overall dimensions* W x H x D mm	310 x 525 x 375
Excess length of drying unit mm	70 back side
Usable interior space W x H x D mm	260 x 480 x 330
Capacity liters	51
Weight kg/approx.	7,3
Maximum all-over load per shelf kg	10
Total all-over load kg	30



47

Automatic-Desiccators



SICCO Practical Tip

Daniel Himmel - Assembly

How do you clean the panels correctly?

With a soft cloth and a usual glass cleaner. Do not use solvent containing cleaner with alcohol.

page 97



Shelves

»» The shelves can be inserted in flexible heights. Even the products in the back of the desiccator are easily reachable due to the telescopic shelves. ««

Technician, Analysis of retain samples

Drying properties

Please read our information on pages 88-95.



SICCO Auto-Star-Desiccator Vitrum

Panels:	Material:	Temperature resistance:	Use:	Stand:
clear	borosilicate 3.3	-20 °C to +120 °C	normal pressure	rubber feet

Specification:

Aluminium frame with panels made of heat-resistant borosilicate glass 3.3, rear panel made of aluminium, including four shelves made of stainless steel, hygrometer and mounted drying unit, usable with up to 26 shelves, stackable. Electrical power connection 230 V / 50 Hz is required.

CE	Cat. No.:	V 1823-07
	Overall dimensions* W x H x D mm	310 x 525 x 375
	Excess length of drying unit mm	70 back side
	Usable interior space W x H x D mm	260 x 480 x 330
	Capacity liters	51
	Weight kg/approx.	13,5
	Maximum all-over load per shelf kg	10
	Total all-over load kg	30

Applications:

Hot, predried products (max. 120 °C) can be stored directly after having been taken out of an oven. The borosilicate glass panels as well as the materials used for the automatic drying unit offer a good chemical resistance against solvents like acetone and ethanol. Please check the chemical resistance before storing any other aggressive products.



SICCO Auto-Big-Star-Desiccator

Panels:	Material:	Temperature resistance:	Use:	Stand:
clear	PMMA	-20 °C to +70 °C	normal pressure	rubber feet

Specification:

Aluminium frame with panels made of acrylic glass, including two shelves made of stainless steel, hygrometer and mounted drying unit, usable with up to 8 shelves. Electrical power connection 230 V / 50 Hz is required.

CE	Cat. No.:	V 1894-07
	Overall dimensions* W x H x D mm	560 x 560 x 580
	Excess length of drying unit mm	100 back side
	Usable interior space W x H x D mm	495 x 500 x 540
	Capacity liters	156
	Weight kg/approx.	22
	Maximum all-over load per shelf kg	30
	Total all-over load kg	80



Add. accessories

Page 77-86.

*Overall dimensions are indicated as follows: width including hinge, height starting from base, depth without handle

SICCO Auto-Maxi 1-Desiccator

Panels: clear	Material: PMMA	Temperature resistance: -20 °C to +70 °C	Use: normal pressure	Stand: casters
------------------	-------------------	---	-------------------------	-------------------

Specification:

Aluminium frame with panels made of acrylic glass, including four shelves made of stainless steel, hygrometer and mounted drying unit, four casters, usable with up to 17 shelves. Electrical power connection 230 V / 50 Hz is required.



Cat. No.:	V 1914-01
Overall dimensions* W x H x D mm	560 x 1150 x 580
Excess length of drying unit mm	100 back side
Usable interior space W x H x D mm	495 x 1030 x 540
Capacity liters	311
Weight kg/approx.	31
Maximum all-over load per shelf kg	30
Total all-over load kg	160

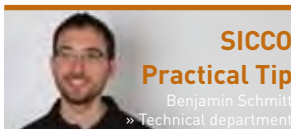

You need more space in your desiccator?

We offer the optimal solution: All desiccators can be equipped with further removable shelves.

page 78-80, 97

SICCO Auto-Maxi 2-Desiccator

Panels: clear	Material: PMMA	Temperature resistance: -20 °C to +70 °C	Use: normal pressure	Stand: casters
------------------	-------------------	---	-------------------------	-------------------

Specification:

Aluminium frame with panels made of acrylic glass, two compartments and two doors, including four shelves made of stainless steel, two hygrometers and mounted drying unit, four casters, usable with up to 8 shelves per compartment. Electrical power connection 230 V / 50 Hz is required.



Cat. No.:	V 1916-01
Overall dimensions* W x H x D mm	560 x 1150 x 580
Excess length of drying unit mm	100 back side
Usable interior space W x H x D mm	495 x 500 x 540 per compartment
Capacity liters	156 per compartment
Weight kg/approx.	35
Maximum all-over load per shelf kg	30
Total all-over load kg	80 per compartment



Drying properties

Please read our information on pages 88-95.

SICCO Auto-Desiccator Wall

Panels: clear	Material: PMMA	Temperature resistance: -20 °C to +70 °C	Use: normal pressure	Stand: casters
-------------------------	--------------------------	--	--------------------------------	--------------------------

Specification:

Aluminium frame with panels made of acrylic glass, six compartments and six doors, including six shelves made of stainless steel, six hygrometers and mounted drying unit, four casters, usable with up to 8 shelves per compartment. Electrical power connection 230 V / 50 Hz is required.

	Cat. No.:	V 1995-08
	Overall dimensions* W x H x D mm	1080 x 1870 x 580
	Excess length of drying unit mm	100 back side
	Usable interior space W x H x D mm	495 x 500 x 540 per compartment
	Capacity liters	156 per compartment
	Weight kg, approx	100
	Maximum all-over load per shelf kg	30
	Maximum all-over load kg	80 per compartment
	Total all-over load kg	200
	Ground clearance of lowest chamber mm	240
	Automatic drying units	2 per compartment





SICCO
Practical Tip
Daniel Himmel | Assembly

How can you accelerate the drying procedure?

By increasing the circulation of air. Just put a small electricity or solar driven ventilator in the inside space.

page 100

 **Add. accessories**
Page 77-86.

*Overall dimensions are indicated as follows: width including hinge, height starting from base, depth without handle

SICCO Antistatic-Desiccators

SICCO Antistatic-Desiccators can protect electronic components against humidity and airborne particulates. Electrostatic charges are discharged by a grounding cable and a charge neutral atmosphere is produced inside the desiccator.

Antistatic-Desiccators are mainly used for temporary storage of components for electronic products.

Feature Summary

- » Connection for grounding cable
- » Door with magnetic catch and circular rubber seal
- » Non-slip rubber feet or four casters (two of the casters with brakes)
- » Easy to read electronic hygrometer
- » Telescopic shelves
- » Reinforced aluminium frame with panels made of antistatic polycarbonate
- » Tray for desiccant
- » Star-Desiccators include Silicagel

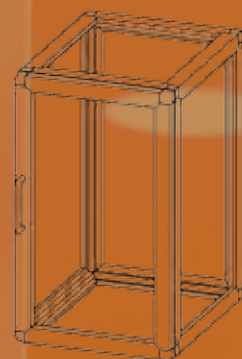

SICCO Star-Desiccator Antistatic

Panels: bluish	Material: PC-ESD	Temperature resistance: -20 °C to +70 °C	Use: normal pressure	Stand: rubber feet
--------------------------	----------------------------	--	--------------------------------	------------------------------

Specification:

Aluminium frame with static dissipative panels made of polycarbonate, including four aluminium shelves, tray, hygrometer and desiccant, usable with up to 26 shelves, stackable. All materials used can discharge electrostatic charging by means of a grounding cable which can be connected on the back side (connecting thread M6).

Cat. No.:	V 1910-07
Overall dimensions* W x H x D mm	310 x 525 x 375
Usable interior space W x H x D mm	260 x 480 x 330
Capacity liters	51
Weight kg/approx.	7
Maximum all-over load per shelf kg	10
Total all-over load kg	30



SICCO Big-Star-Desiccator Antistatic

Panels: bluish	Material: PC-ESD	Temperature resistance: -20 °C to +70 °C	Use: normal pressure	Stand: rubber feet
--------------------------	----------------------------	--	--------------------------------	------------------------------

Specification:

Aluminium frame with static dissipative panels made of polycarbonate, including two shelves made of stainless steel, tray and hygrometer, usable with up to 17 shelves. All materials used can discharge electrostatic charging by means of a grounding cable which can be connected on the back side (connecting thread M6).

Cat. No.:	V 1925-07
Overall dimensions* W x H x D mm	560 x 560 x 580
Usable interior space W x H x D mm	495 x 500 x 540
Capacity liters	156
Weight kg/approx.	18
Maximum all-over load per shelf kg	30
Total all-over load kg	80



Add. accessories

Page 77-86.



SICCO INNOVATION

Desiccators for wall-mounting

A space-saving alternative to the standard desiccator is the desiccator for wall-mounting. We as manufacturer offer your customized wall-mounted desiccator.

page 84, 98

SICCO Maxi 1-Desiccator Antistatic

Panels:	Material:	Temperature resistance:	Use:	Stand:
bluish	PC-ESD	-20 °C to +70 °C	normal pressure	casters

Specification:

Aluminium frame with static dissipative panels made of polycarbonate, including four shelves made of stainless steel, tray and hygrometer, four casters with static dissipative tread, usable with up to 34 shelves. All materials used can discharge electrostatic charging by means of a grounding cable which can be connected on the back side (connecting thread M6).

Cat. No.:	V 1922-07
Overall dimensions* W x H x D mm	560 x 1150 x 580
Usable interior space W x H x D mm	495 x 1030 x 540
Capacity liters	311
Weight kg/approx.	30
Maximum all-over load per shelf kg	30
Total all-over load kg	160



SICCO Maxi 2-Desiccator Antistatic

Panels:	Material:	Temperature resistance:	Use:	Stand:
bluish	PC-ESD	-20 °C to +70 °C	normal pressure	casters

Specification:

Aluminium frame with static dissipative panels made of polycarbonate, two compartments and two doors, including four shelves made of stainless steel, two trays and two hygrometers, four casters with static dissipative tread, usable with up to 17 shelves per compartment. All materials used can discharge electrostatic charging by means of a grounding cable which can be connected on the back side (connecting thread M6).

Cat. No.:	V 1923-07
Overall dimensions* W x H x D mm	560 x 1150 x 580
Usable interior space W x H x D mm	495 x 500 x 540 per compartment
Capacity liters	156 per compartment
Weight kg/approx.	34
Maximum all-over load per shelf kg	30
Total all-over load kg	80 per compartment



Drying properties

Please read our information on pages 88-95.

SICCO Mini-Desiccator Antistatic Basic

Panels: black	Material: PC-ESD	Temperature resistance: -35 °C to +70 °C	Use: normal pressure
-------------------------	----------------------------	--	--------------------------------

Specification:

Black, static dissipative polycarbonate, including desiccant, stackable. All materials used can discharge electrostatic charging by means of a grounding cable which can be connected on the back side (bore dia. 4,3 mm).

Cat.No.:	V 1843-06
Overall dimensions* W x H x D mm	221 x 182 x 214
Usable interior space W x H x D mm	212 x 162 x 180
Capacity liters	6,2
Weight kg.	0,9
Total all-over load kg	3
Surface resistivity Ohm	10 ⁵



SICCO Mini-Desiccator Antistatic Premium

Panels: black	Material: PC-ESD	Temperature resistance: -35 °C to +70 °C	Use: normal pressure
-------------------------	----------------------------	--	--------------------------------

Specification:

Black, static dissipative polycarbonate, including two shelves made of static dissipative polyethylene, hygrometer and desiccant, non-slip rubber feet, stackable. All materials used can discharge electrostatic charging by means of a grounding cable which can be connected on the back side (bore dia. 4,3 mm).

Cat.No.:	V 1943-06
Overall dimensions* W x H x D mm	221 x 182 x 214
Usable interior space W x H x D mm	212 x 162 x 180
Capacity liters	6,2
Weight kg.	0,9
Maximum all-over load per shelf kg	2
Total all-over load kg	3
Surface resistivity Ohm	10 ⁵



Add. accessories

Page 77-86.

*Overall dimensions are indicated as follows: width including hinge, height starting from base, depth without handle

SICCO Desiccator Wall Antistatic

Panels:	Material:	Temperature resistance:	Use:	Stand:
bluish	PC-ESD	-20 °C to +70 °C	normal pressure	casters

Specification:

Aluminium frame with static dissipative panels made of polycarbonate, six compartments and six doors, including six shelves made of stainless steel, six trays and six hygrometers, four casters with static dissipative tread, usable with up to 17 shelves per compartment. All materials used can discharge electrostatic charging by means of a grounding cable which can be connected on the back side (connecting thread M6).

Cat. No.:	V 1997-08
Overall dimensions* W x H x D mm	1080 x 1870 x 580
Usable interior space W x H x D mm	495 x 500 x 540 per compartment
Capacity liters	156 per compartment
Weight kg, approx	100
Maximum all-over load per shelf kg	30
Maximum all-over load kg	80 per compartment
Total all-over load kg	200
Ground clearance of lowest chamber mm	240





SICCO
Practical Tip

Marion Hammerich » Construction

How can you reduce the air exchange when opening the door?

Form an artificial wall by putting large jars in the front part of the desiccator or glue a paper or a film in the gaps.

page 100

Drying properties

Please read our information on pages 88-95.





SICCO offers custom manufacture.

Every lab is different. By offering an extensive range of established and sophisticated standard solutions we take into account the varied requirements of the respective branches and sectors.

But maybe you are looking for something special? Something that is not included in our standard product range?

In that case we are able to offer an individual custom manufacture. This is easier and faster than you may expect. Discuss your idea with our professionals. They will give advise and support during design. Finally, your idea will become real: We produce as per your requirements and in compliance with the chosen raw materials – already from 1 piece.

We only need a drawing (a sketch is sufficient) and some further information.

» **You have a special request?**

Give us a call: +49 (0) 93 46-92 86-0.

SICCO Vacuum-Desiccators

SICCO Vacuum-Desiccators are suitable for storing sensitive products in a vacuum. The vacuum inside the desiccator ensures rapid drying of the stored products.

These systems allow storage in an oxygen and carbon dioxide free environment and are, for example, suitable for storage of semiconductor samples.

Feature Summary

- » Clear acrylic panels, interior is visible from all sides
- » Circular silicone seal
- » Non-slip rubber feet
- » Variable height shelves
- » Vacuum gauge (0-760 mm of mercury)
- » Vacuum up to 10^{-4} Torr
- » Two needle valves with O.D. 9.0 mm

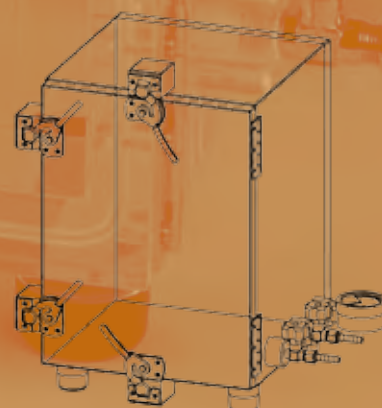



BESTSELLER

SICCO Vacuum 1-Desiccator

Panels: clear	Material: PMMA	Temperature resistance: -20 °C to +70 °C	Use: Vacuum up to 10 ⁻⁴ Torr	Stand: rubber feet
------------------	-------------------	---	--	-----------------------

Specification:

Massive acrylic glass (wall thickness 20 mm), door with circular silicone gasket and four latches, vacuum gauge, two needle valves with hose connectors, including two shelves, usable with up to three shelves.

Cat. No.:	V 1880-04
Overall dimensions* W x H x D mm	300 x 340 x 300
Excess length of valves + vacuum gauge mm	100
Usable interior space W x H x D mm	260 x 260 x 260
Capacity liters	18
Weight kg	15
Maximum all-over load kg	9
Total all-over load kg	30



Vacuum Desiccators

» By means of the SICCO Vacuum Desiccators we can evacuate our samples and eliminate water or volatile solvents. Contamination in the subsequent analytical examinations is avoided and the results are correct.



Staff Member Research & Development

*Overall dimensions are indicated as follows: width including hinge, height starting from base, depth without handle

SICCO Vacuum 2-Desiccator

Panels: clear	Material: PMMA	Temperature resistance: -20 °C to +70 °C	Use: Vacuum up to 10⁻⁴ Torr	Stand: rubber feet
-------------------------	--------------------------	--	--	------------------------------

Specification:

Massive acrylic glass (wall thickness 20 mm), door with circular silicone gasket and four latches, vacuum gauge, two needle valves with hose connectors, including three shelves, usable with up to 5 shelves.

Cat. No.:	V 1880-08
Overall dimensions* W x H x D mm	300 x 440 x 300
Excess length of valves + vacuum gauge mm	100
Usable interior space W x H x D mm	260 x 360 x 260
Capacity liters	25
Weight kg	18
Maximum all-over load kg	9
Total all-over load kg	40



SICCO Vacuum 3-Desiccator

Panels: clear	Material: PMMA	Temperature resistance: -20 °C to +70 °C	Use: Vacuum up to 10⁻⁴ Torr	Stand: rubber feet
-------------------------	--------------------------	--	--	------------------------------

Specification:

Massive acrylic glass (wall thickness 25 mm), door with circular silicone gasket and 5 latches, vacuum gauge, two needle valves with hose connectors, including four shelves, usable with up to 7 shelves.

Cat. No.:	V 1880-12
Overall dimensions* W x H x D mm	315 x 550 x 310
Excess length of valves + vacuum gauge mm	100
Usable interior space W x H x D mm	265 x 460 x 260
Capacity liters	32
Weight kg	27
Maximum all-over load kg	9
Total all-over load kg	50



SICCO Vacuum-Desiccator Toploader

Panels: clear	Material: PMMA	Temperature resistance: -20 °C to +70 °C	Use: Vacuum up to 10 ⁻⁴ Torr	Stand: rubber feet
------------------	-------------------	---	--	-----------------------

Specification:

Massive acrylic glass (wall thickness 20 mm), Toploader version, hinged lid opening with circular silicone gasket and four latches, vacuum gauge, two needle valves with hose connectors integrated in the hinged lid.

Cat. No.:	V 1882-02
Overall dimensions* W x H x D mm	250 x 250 x 250
Usable interior space W x H x D mm	210 x 210 x 210
Capacity liters	9
Weight kg	9
Total all-over load kg	30



SICCO Glove Boxes/Extractor Hoods

The SICCO Glove Boxes allow safe working with sensitive compounds in a controlled environment. The natural rubber gloves provide with the necessary mobility for safe handling.

The connectors for gas-filling allow to flush the workspace as well as the transfer chamber with inert gas. By means of the transfer chamber, the glove boxes can be easily loaded.

Feature Summary

- » Robust and light-weight aluminium construction
- » Large front opening
- » Superb all-round visibility, non-glare
- » Non-slip rubber feet
- » Cable lead-ins for electric devices
- » Connectors for gas-filling and aeration including appropriate tubing
- » Transfer chamber for inserting further products

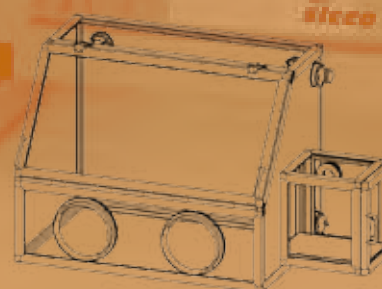



How to work with the SICCO Glove Box with Transfer Chamber

Glove Boxes are used whenever sensitive or hazardous materials have to be processed in an isolated environment.

With the big opening, all necessary equipment such as balances, syringes, or pipettes can be installed prior to start your work. Electrical power supply is assured by the integrated lead-ins for cables on the back side - any standard cables with an outer diameter from 0,1 up to 10 mm can be led in including mounted plugs. Furthermore probes for e. g. monitoring the oxygen content as well as tubes can be installed, if necessary, by using the lead-ins on the back side (see page 98).

Once the door is closed, the inner space can be flushed with nitrogen or inert gas by using the integrated connectors for gas-filling.

Particular attention is paid to ergonomics: The position of the glove ports allows to use the full capacity. The tilted door panel provides a glare-free and good sight on the interior.

Using the transfer chamber, additional products can be easily inserted into the glove box. Upon opening of the inner door, the tray extends into the interior for easy access to inserted products. The transfer chamber can be independently filled with gas.

You are looking for a glove box with different dimensions or need further options? Its modular construction with a frame made of aluminium profiles and acrylic glass panels allows to adapt our glove box to your special requirements.



Add. accessories

Page 77-86.

BESTSELLER

SICCO Glove Box with Transfer Chamber

Panels: clear	Material: PMMA	Temperature resistance: -20 °C to +70 °C	Use: normal pressure	Stand: rubber feet
------------------	-------------------	---	-------------------------	-----------------------

Specification:

Aluminium frame with panels made of acrylic glass, base panel made of polyethylene. Front panel with two glove ports and one pair of natural rubber gloves size 9, two lead-ins for cables on the back side (upper left and upper right).

Transfer chamber with two doors, external door with latch to prevent accidental opening, the tray extends into the workspace with opening of the internal door for easy removal of inserted products. Work space and transfer chamber each including two hose connectors for gas-filling and aeration and appropriate tubing (2x 5m tubing for gas-filling made of PVC and 2x 5 m aeration tubing made of PE).

Cat. No. :	V 1982-08
Overall dimensions* W x H x D mm	1210 x 700 x 600
Add. space requirement for coupling mm	150
Usable interior space W x H x D mm	850 x 650 x 540
Usable volume litres	290
Weight kg, approx.	20
Maximum all-over load kg	40
Opening for gloves mm	ø 190
Distance between opening for gloves mm	390
Hinged lid opening W x H mm	850 x 425
Bore diameter connector for gas-filling mm	ø 9
Bore diameter in panels mm	ø 16,5
Details transfer chamber:	
Overall dimensions* W x H x D mm	320 x 330 x 260
Usable interior space W x H x D mm	220 x 275 x 320
Usable volume litres, approx.	24
Maximum usable height mm	275 » 1000 ml flask with thread GL 45
Maximum usable width mm	200
Maximum all-over load kg	3

«
Special Request?
+49 (0) 93 46 92 86-0
»



SICCO Practical Tip

Uwe Hossfeld » Technical department

You would like to flush your desiccator with gas in a controlled way?

Using the SICCO Gas Dosing Controller, the gas inlet is automatically regulated in dependence of the inside relative humidity.

page 102

Glove Box

»» The large Swing-up door that is to be opened upwards allows a comfortable experiment set-up. It is space saving, this is what has convinced us. ««

Lab assistant catalyst research

Drying properties

Please read our information on pages 88-95.

SICCO Glove Box Vitrum with Transfer Chamber

Panels:	Material:	Temperature resistance:	Use:	Stand:
clear	borosilicate 3.3	-20 °C to +120 °C	normal pressure	rubber feet

Specification:

Aluminium frame with panels made of borosilicate glass, front panel with two glove ports, right side panel and bottom side base panel made of aluminium, top side of base panel made of stainless steel. Including one pair of natural rubber gloves size 9, two lead-ins for cable on the back side (upper left and upper right).

Transfer chamber with two doors, external door with latch to prevent accidental opening, the tray extends into the workspace with opening of the internal door for easy removal of inserted products. Work space and transfer chamber each including two hose connectors for gas-filling and aeration and appropriate tubing (2x 5m tubing for gas-filling made of PVC and 2x 5 m aeration tubing made of PE).

Cat. No. :	V 1986-08
Overall dimensions* W x H x D mm	1210 x 700 x 600
Add. space requirement for coupling mm	150
Usable interior space W x H x D mm	850 x 650 x 540
Usable volume litres	290
Weight kg, approx.	36
Maximum all-over load kg	40
Opening for gloves mm	ø 190
Distance between opening for gloves mm	390
Hinged lid opening W x H mm	850 x 425
Bore diameter connector for gas-filling mm	ø 9
Bore diameter in panels mm	ø 16,5

Details transfer chamber:

Overall dimensions* W x H x D mm	320 x 330 x 260
Usable interior space W x H x D mm	220 x 275 x 320
Usable volume litres, approx.	24
Maximum usable height mm	275 » 1000 ml flask with thread GL 45
Maximum usable width mm	200
Maximum all-over load kg	3

Applications:

The workspace is made of materials with good chemical resistance (aluminium, stainless steel, borosilicate glass) for handling of aggressive products.



SICCO INNOVATION

Cable lead-ins

You can use electronic devices inside your desiccator with the specially designed cable lead-ins.

page 101



Add. accessories

Page 77-86.

*Overall dimensions are indicated as follows: width including hinge, height starting from base, depth without handle

SICCO Glove Box

Panels: clear	Material: PMMA	Temperature resistance: -20 °C to +70 °C	Use: normal pressure	Stand: rubber feet
-------------------------	--------------------------	--	--------------------------------	------------------------------

Specification:

Aluminium frame with panels made of acrylic glass, base panel made of polyethylene. Front panel with two glove ports and one pair of natural rubber gloves size 9, two lead-ins for cables on the back side (upper left and upper right).

Work space and transfer chamber each including two hose connectors for gas-filling and aeration and appropriate tubing (1x 5m tubing for gas-filling made of PVC and 1x 5 m aeration tubing made of PE).

Cat. No. :	V 1984-08
Overall dimensions* W x H x D mm	890 x 700 x 600
Add. space requirement for coupling mm	150
Usable interior space W x H x D mm	850 x 650 x 540
Capacity liters	290
Weight kg, approx.	14
Maximum all-over load kg	40
Opening for gloves mm	ø 190
Distance between opening for gloves mm	390
Hinged lid opening W x H mm	850 x 425
Bore diameter connector for gas-filling mm	ø 9
Bore diameter in panels mm	ø 16,5



Glove Boxes

- » SICCO Glove Boxes are equipped with an Aluminium frame and glass-fiber reinforced corner connectors and, thus, specially stable. They are perfectly suitable for our application. «

Process Engineer



SICCO Glove Box with Transfer Chamber Antistatic

Panels: bluish	Material: PC-ESD	Temperature resistance: -20 °C to +70 °C	Use: normal pressure	Stand: rubber feet
--------------------------	----------------------------	--	--------------------------------	------------------------------

Specification:

Aluminium frame with static dissipative panels made of polycarbonate, base panel made of static dissipative polyethylene. Front panel with two glove ports and one pair of static dissipative EPDM gloves size 9,75, two lead-ins for cables on the back side (upper left and upper right). Transfer chamber with two doors, external door with latch to prevent accidental opening, the tray extends into the workspace with opening of the internal door for easy removal of inserted products. Work space and transfer chamber each including two hose connectors for gas-filling and aeration and appropriate tubing (2x 5m tubing for gas-filling made of PVC and 2x 5 m aeration tubing made of PE). All materials used can discharge electrostatic charging by means of a grounding cable which can be connected on the back side (connecting thread M6).

Cat. No.:	V 1992-08
Overall dimensions* W x H x D mm	1210 x 700 x 600
Add. space requirement for coupling mm	150
Usable interior space W x H x D mm	850 x 650 x 540
Usable volume litres	290
Weight kg, approx.	20
Maximum all-over load kg	40
Opening for gloves mm	ø 190
Distance between opening for gloves mm	390
Hinged lid opening W x H mm	850 x 425
Bore diameter connector for gas-filling mm	ø 9
Bore diameter in panels mm	ø 16,5
Details transfer chamber:	
Overall dimensions* W x H x D mm	320 x 330 x 260
Usable interior space W x H x D mm	220 x 275 x 320
Usable volume litres, approx.	24
Maximum usable height mm	275 » 1000 ml flask with thread GL 45
Maximum usable width mm	200
Maximum all-over load kg	3



Add. accessories

Page 77-86.

*Overall dimensions are indicated as follows: width including hinge, height starting from base, depth without handle

BESTSELLER

SICCO Glove Box for Exhaustion

Panels: clear	Material: PMMA	Temperature resistance: -20 °C to +70 °C	Use: normal pressure	Stand: rubber feet
-------------------------	--------------------------	--	--------------------------------	------------------------------

Specification:

Aluminium frame with panels made of acrylic glass. Base panel, integrated connector for exhaust system and closing lid made of polyethylene. Iris-Ports and cable lead-ins made of polyethylene and silicone. Two lead-ins for cable on the back side (upper left and upper right). Two crosswise slotted silicone discs each in the openings and cable lead-ins. They are staggered mounted so that the overlapping segments at the same time allow easy access to the interior space and close the openings at non-use. The Iris-ports ensure pressure compensation through air streaming when the exhaust system is switched on. Connection to exhaust system through an integrated connector on the top panel. This connector is graded for tubes with inner diameters 100, 120, 160 and 180 mm. When working without exhaust system the opening can be closed with a lid.

Cat. No.:	V 1988-08
Overall dimensions * W x H x D in mm	890 x 700 x 600
Usable interior space W x H x D in mm	850 x 650 x 540
Usable volume Litres	290
Weight kg, approx.	16
Maximum all-over load kg	40
Openings mm	ø 170
Distance between openings mm	390
Hinged lid opening W x H in mm	850 x 425
Connector for exhaust system Ø in mm, graded	100, 120, 160, 180

Applications:

Direct connection to an existing exhaust system through the integrated connector. Easy access to the interior space through Iris-ports, no complex change of gloves.

« »
Special Request?
+49 (0) 93 46 92 86-0



67

Glove Boxes/Extractor Hoods



Drying properties

Please read our information on pages 88-95.

SICCO Glove Box Trio with Transfer Chamber

Panels: clear	Material: PMMA	Temperature resistance: -20 °C to +70 °C	Use: normal pressure	Stand: rubber feet
-------------------------	--------------------------	--	--------------------------------	------------------------------

Specification:

Aluminium frame with panels made of acrylic glass, base panel made of polyethylene. Front side with three glove ports and two pairs of natural rubber gloves size 9, three cable lead-ins on the back side (upper right, middle, left). Transfer chamber (right) with two doors, external door with latch to prevent accidental opening, the tray extends into the workspace with opening of the internal door for easy removal of inserted products. Work space and transfer chamber including two hose connectors for gas-filling each and appropriate tubing (2x 5 m tubing for gas-filling made of PVC and 2x 5 m aeration tubing made of PE).

Cat. No.:	V 1750-08
Overall dimensions* W x H x D mm	1590 x 690 x 590
Usable interior space W x H x D mm	1240 x 650 x 550
Usable volume litres	440
Weight kg, approx.	28
Maximum all-over load kg	60
Opening for gloves mm	ø 190
Distance between opening for gloves mm	390
Hinged lid opening W x H mm	1240 x 425
Bore diameter connector for gas-filling mm	ø 9
Bore diameter in panels mm	ø 74,5

Details transfer chamber:

Overall dimensions* W x H x D mm	320 x 330 x 260
Usable interior space W x H x D mm	220 x 275 x 320
Usable volume litres, approx.	24
Maximum usable height mm	275 <small>» 1000 ml flask with thread GL 45</small>
Maximum usable width mm	200
Maximum all-over load kg	3

Applications:

Large interior space with big door. Devices for working processes in a row can be installed in one glove box. Flexible assembly of the third glove port due to second pair of gloves in the scope of delivery.



SICCO INNOVATION

Closing lid for glove port

While the glove box is not operated or the gloves have been removed for cleaning, the lids provide a dust-proof closing of the ports.

page 86, 104



Add. accessories

Page 77-86.

*Overall dimensions are indicated as follows: width including hinge, height starting from base, depth without handle

SICCO Glove Box Duo 1 with Transfer Chambers

Panels: clear	Material: PMMA	Temperature resistance: -20 °C to +70 °C	Use: normal pressure	Stand: rubber feet
------------------	-------------------	---	-------------------------	-----------------------

Specification:

Aluminium frame with panels made of acrylic glass, base panel made of polyethylene. Front side with four glove ports and two pairs of natural rubber gloves size 9, three cable lead-ins on the back side (upper right, middle, left). Two transfer chambers (right and left) with two doors each, external doors with latch to prevent accidental opening, the tray extends into the workspace with opening of the internal door for easy removal of inserted products. Work space and transfer chambers including two hose connectors for gas-filling each and appropriate tubing (3x 5 m tubing for gas-filling made of PVC and 3x 5 m aeration tubing made of PE).

Cat. No.:	V 1730-08
Overall dimensions* W x H x D mm	2345 x 690 x 590
Usable interior space W x H x D mm	1680 x 650 x 550
Usable volume litres	600
Weight kg, approx.	40
Maximum all-over load kg	80
Opening for gloves mm	ø 190
Distance between opening for gloves mm	390
Hinged lid opening W x H mm	1680 x 425
Bore diameter connector for gas-filling mm	ø 9
Bore diameter in panels mm	ø 74,5
Details transfer chambers:	
Overall dimensions* W x H x D mm	320 x 330 x 260
Usable interior space W x H x D mm	220 x 275 x 320
Usable volume litres, approx.	24
Maximum usable height mm	275 » 1000 ml flask with thread GL 45
Maximum usable width mm	200
Maximum all-over load kg	3

Applications:

Large interior space with big door. Devices for working processes in a row for two workstations can be installed in one glove box. The glove port positions allow an easy pass-through of working materials from one transfer chamber to the other.

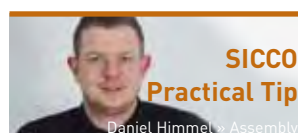

How do you clean the panels correctly?

With a soft cloth and a usual glass cleaner. Do not use solvent containing cleaner with alcohol.

page 97

Drying properties

Please read our information on pages 88-95.



SICCO Glove Box Duo 2 with Transfer Chamber

Panels:	Material:	Temperature resistance:	Use:	Stand:
clear	PMMA	-20 °C to +70 °C	normal pressure	rubber feet

Specification:

Aluminium frame with panels made of acrylic glass, base panel made of polyethylene. Front and back side with one door each, two pairs of opposite glove ports each with one pair of natural rubber gloves size 9, two cable lead-ins (left bottom side). Transfer chamber (right) with two doors, external door with latch to prevent accidental opening, the tray extends into the workspace with opening of the internal door for easy removal of inserted products. The tray is only operable from one workstation side (front right-hand). Work space and transfer chamber including two hose connectors for gas-filling each and appropriate tubing (2x 5 m tubing for gas-filling made of PVC and 2x 5 m aeration tubing made of PE).

Cat. No.:	V 1710-08
Overall dimensions* W x H x D mm	1200 x 710 x 890
Usable interior space W x H x D mm	850 x 665 x 845
Usable volume litres	475
Weight kg, approx.	30
Maximum all-over load kg	60
Opening for gloves mm	ø 190
Distance between opening for gloves mm	390
Hinged lid opening W x H mm	850 x 425
Bore diameter connector for gas-filling mm	ø 9
Bore diameter in panels mm	ø 74,5

Details transfer chamber:

Overall dimensions* W x H x D mm	320 x 330 x 260
Usable interior space W x H x D mm	220 x 275 x 320
Usable volume litres, approx.	24
Maximum usable height mm	275 » 1000 ml flask with thread GL 45
Maximum usable width mm	200
Maximum all-over load kg	3

Applications:

Large interior space with two big doors. Two opposite workstations allow operation from two sides at the same time. Working with bulky or heavy goods is easier through a second pair of hands.

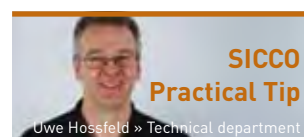

The gas consumption of your glove box is too high?

Just mount the Gas-saving valve on your aeration tubing for a nearly gas-tight closure. The pass opens automatically for pressure compensation.

page 84, 101



Add. accessories

Page 77-86.

*Overall dimensions are indicated as follows: width including hinge, height starting from base, depth without handle

SICCO Glove Box Duo 1 with Transfer Chambers Antistatic

Panels:	Material:	Temperature resistance:	Use:	Stand:
bluish	PC-ESD	-20 °C to +70 °C	normal pressure	rubber feet

Specification:

Aluminium frame with static dissipative panels made of polycarbonate, base panel made of static dissipative polyethylene. Front side with four glove ports and two pairs of static dissipative EPDM gloves size 9,75, three cable lead-ins on the back side (upper right, middle, left). Two transfer chambers (right and left) with two doors each, external doors with latch to prevent accidental opening, the tray extends into the workspace with opening of the internal door for easy removal of inserted products. Work space and transfer chambers including two hose connectors for gas-filling each and appropriate tubing (3x 5 m tubing for gas-filling made of PVC and 3x 5 m aeration tubing made of PE). All materials used can discharge electrostatic charging by means of a grounding cable which can be connected on the back side (connecting thread M6)

Cat. No.:	V 1735-08
Overall dimensions* W x H x D mm	2345 x 690 x 590
Usable interior space W x H x D mm	1680 x 650 x 550
Usable volume litres	600
Weight kg, approx.	44
Maximum all-over load kg	80
Opening for gloves mm	ø 190
Distance between opening for gloves mm	390
Hinged lid opening W x H mm	1680 x 425
Bore diameter connector for gas-filling mm	ø 9
Bore diameter in panels mm	ø 74,5
Details transfer chambers:	
Overall dimensions* W x H x D mm	320 x 330 x 260
Usable interior space W x H x D mm	220 x 275 x 320
Usable volume litres, approx.	24
Maximum usable height mm	275 » 1000 ml flask with thread GL 45
Maximum usable width mm	200
Maximum all-over load kg	3

Applications:

Large interior space with big door. Devices for working processes in a row for two workstations can be installed in one glove box. The glove port positions allow an easy pass-through of working materials from one transfer chamber to the other.



SICCO INNOVATION

Closing lid for glove port

While the glove box is not operated or the gloves have been removed for cleaning, the lids provide a dust-proof closing of the ports.

page 86, 104



Drying properties

Please read our information on pages 88-95.

SICCO Glove Box Duo 2 with Transfer Chamber Antistatic

Panels: bluish	Material: PC-ESD	Temperature resistance: -20 °C to +70 °C	Use: normal pressure	Stand: rubber feet
--------------------------	----------------------------	--	--------------------------------	------------------------------

Specification:

Aluminium frame with static dissipative panels made of polycarbonate, base panel made of static dissipative polyethylene. Front and back side with one door each, two pairs of opposite glove ports each with one pair of static dissipative EPDM gloves size 9,75, two cable lead-ins (left bottom side). Transfer chamber (right) with two doors, external door with latch to prevent accidental opening, the tray extends into the workspace with opening of the internal door for easy removal of inserted products. The tray is only operable from one workstation side (front right-hand). Work space and transfer chamber including two hose connectors for gas-filling each and appropriate tubing (2x 5 m tubing for gas-filling made of PVC and 2x 5 m aeration tubing made of PE). All materials used can discharge electrostatic charging by means of a grounding cable which can be connected on the back side (connecting thread M6).

Cat. No.:	V 1715-08
Overall dimensions* W x H x D mm	1200 x 710 x 890
Usable interior space W x H x D mm	850 x 665 x 845
Usable volume litres	475
Weight kg, approx.	32
Maximum all-over load kg	60
Opening for gloves mm	ø 190
Distance between opening for gloves mm	390
Hinged lid opening W x H mm	850 x 425
Bore diameter connector for gas-filling mm	ø 9
Bore diameter in panels mm	ø 74,5
Details transfer chamber:	
Overall dimensions* W x H x D mm	320 x 330 x 260
Usable interior space W x H x D mm	220 x 275 x 320
Usable volume litres, approx.	24
Maximum usable height mm	275 <small>» 1000 ml flask with thread GL 45</small>
Maximum usable width mm	200
Maximum all-over load kg	3

Applications:

Large interior space with two big doors. Two opposite workstations allow operation from two sides at the same time. Working with bulky or heavy goods is easier through a second pair of hands.

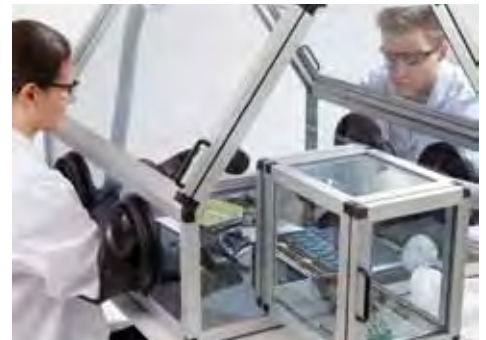

Add. accessories

Page 77-86.

*Overall dimensions are indicated as follows: width including hinge, height starting from base, depth without handle

SICCO Gas Dosing Controller

Specification:

Controls the inlet of gas into the SICCO Glove Box to reduce gas consumption. The set consists of a gas dosing controller, a sensor cable, a tubing for connecting the flow meter with the measuring instrument and a power cable. Electrical power connection 230 V / 50 Hz as well as two free cable lead-ins, one for gas supply and one for the sensor, are required.



Artikel-Nr.:	V 1775-02
Setting Range Humidity:	0 – 50 % rH
Setting Range Temperature:	from -20 °C up to +60 °C
Display Range:	0,1 – 99 % rH, -30 °C up to +70 °C
Accuracy of Sensor:	+/- 3 % rH, +/- 0,5 °C
Resolution:	0,1 % rH, 0,1 °C
Gas Flow Meter:	2 – 10 Litres/min
Length of sensor cable:	1,2 m
Weight:	1800 g

Applications:

The control of gas supply is determined by the relative humidity inside the glove box, the relative humidity is monitored by a sensor which has to be led into the glove box by using a cable lead-in. When the required residual humidity is reached, the gas supply will be stopped. In case of a deviation larger than 1 % from the adjusted value, the pass opens and gas is led into the glove box again.



How it works:

To achieve a constant humidity inside the work space of your glove box, it is recommended to use the SICCO Gas Dosing Controller, which is installed between the gas tap and the glove box. For operation, two free cable lead-ins are required. One for inserting the sensor and the other one for connecting the tube of the Gas Dosing Controller with the work space of the glove box. Simply adjust the required relative humidity directly on the Gas Dosing Controller, the gas supply is open. When the adjusted value is reached, the supply on the Gas Dosing Controller closes. The sensor inside the work space constantly monitors humidity. Once humidity deviates for more than 1 % of the adjusted value, the gas supply automatically opens again after 3 minutes. Thus, humidity is kept on the same level. The time lag of 3 minutes prevents an unnecessary inlet of gas, for example, if the door of the glove box is only opened for a short period of time. For a deviation larger than 5 % an alarm signal sounds. Such a deviation might occur, for example, if the door is permanently opened or if the gas bottle is empty. By means of the automatic switch-on and switch-off function you can save up to 60 % of gas.



SICCO INNOVATION

Gas Dosing Controller

Using the SICCO Gas Dosing Controller, the gas inlet is automatically regulated in dependence of the inside relative humidity.

page 102



Drying properties

Please read our information on pages 88-95.

SICCO Mini Glove Box

Panels: clear	Material: PMMA	Temperature resistance: -20 °C to +70 °C	Use: normal pressure	Stand: rubber feet
-------------------------	--------------------------	--	--------------------------------	------------------------------

Specification:

Panels and base panel made of acrylic glass, glove ports sideways with Iris ports (one on the right-hand side, one on the left-hand side).

Cat. No.:	V 1705-08
Overall dimensions * W x H x D mm	300 x 400 x 400
Usable interior space W x H x D mm	290 x 390 x 390
Usable volume litres	34
Weight kg, approx.	5,7
Maximum all-over load kg	10
Opening for gloves mm	ø 190

Applications:

For easy handling of small quantities in a closed working space. Easily transportable due to their light weight. Iris Ports can be easily exchanged by simple gloves for ports with Ø 190 mm for tight sealing.



Add. accessories

Page 77-86.

*Overall dimensions are indicated as follows: width including hinge, height starting from base, depth without handle

SICCO Rack for Glove Box

Material: **Aluminium** Stand: **rubber feet** Use: **seated work position**

Specification:

Frame, side walls and rear wall made of Aluminium, including four connectors. The rack is adapted for seated work positions, so that all areas of the glove box can be reached when seated. The table area conforms to the base of the SICCO Glove Box. Additional storage shelf under the Glove Box. The rack is delivered ready assembled, only the Glove Box has to be fixed on the rack with the four connectors to prevent a slipping of the unit.

Cat. No.:	V 1963-02
Overall dimensions W x H x T in mm	890 x 720 x 600
Weight kg, ca.	17
Total all-over load kg	100

Application:

For installation of an ergonomic glove box workplace.



SICCO Rack for Glove Box

Material: **Aluminium** Stand: **rubber feet** Use: **standing work position**

Specification:

Frame, side walls and rear wall made of Aluminium, including four connectors. The height is adapted for standing work positions, the table area conforms to the base of the SICCO Glove Box. Additional storage shelf under the Glove Box. The rack is delivered ready assembled, only the Glove Box has to be fixed on the rack with the four connectors to prevent a slipping of the unit.

Cat. No.:	V 1962-02
Overall dimensions W x H x T in mm	890 x 1090 x 600
Weight kg, ca.	24
Total all-over load kg	100

Application:

For installation of workplaces with standing work position.



Drying properties

Please read our information on pages 88-95.

SICCO Extractor Hoods

Panels: **clear** Material: **PC/PP** Temperature resistance: **-20 °C to +70 °C**

Specification:

Aluminium frame with panels made of polycarbonate, top panel with integrated connector for exhaust system made of polypropylene.

Cat.No.:	V 1960-02
Overall dimensions W x H x D mm	900 x 900 x 600
Usable interior space W x H x D mm	860 x 880 x 560
Opening W x H mm	545 x 600
Connector Ø	DN 160
Weight kg. approx.	20

Cat.No.:	V 1960-04
Overall dimensions W x H x D mm	1200 x 900 x 600
Usable interior space W x H x D mm	1160 x 880 x 560
Opening W x H mm	850 x 600
Connector Ø	DN 160
Weight kg. approx.	23

« »
Special Request?
+49 (0) 93 46 92 86-0



Add. accessories

Page 77-86.

*Overall dimensions are indicated as follows: width including hinge, height starting from base, depth without handle

On the following pages you can find practical accessories which will help you to adapt your SICCO Desiccators and Glove Boxes to your application.

Increase space for your humidity sensitive products by using additional shelves or drawers.

Monitor the exact conditions inside the desiccators with a hygrometer or a humidity-temperature probe with USB-interface.

Hoses, trays, desiccant?
Just take a look at the following pages!

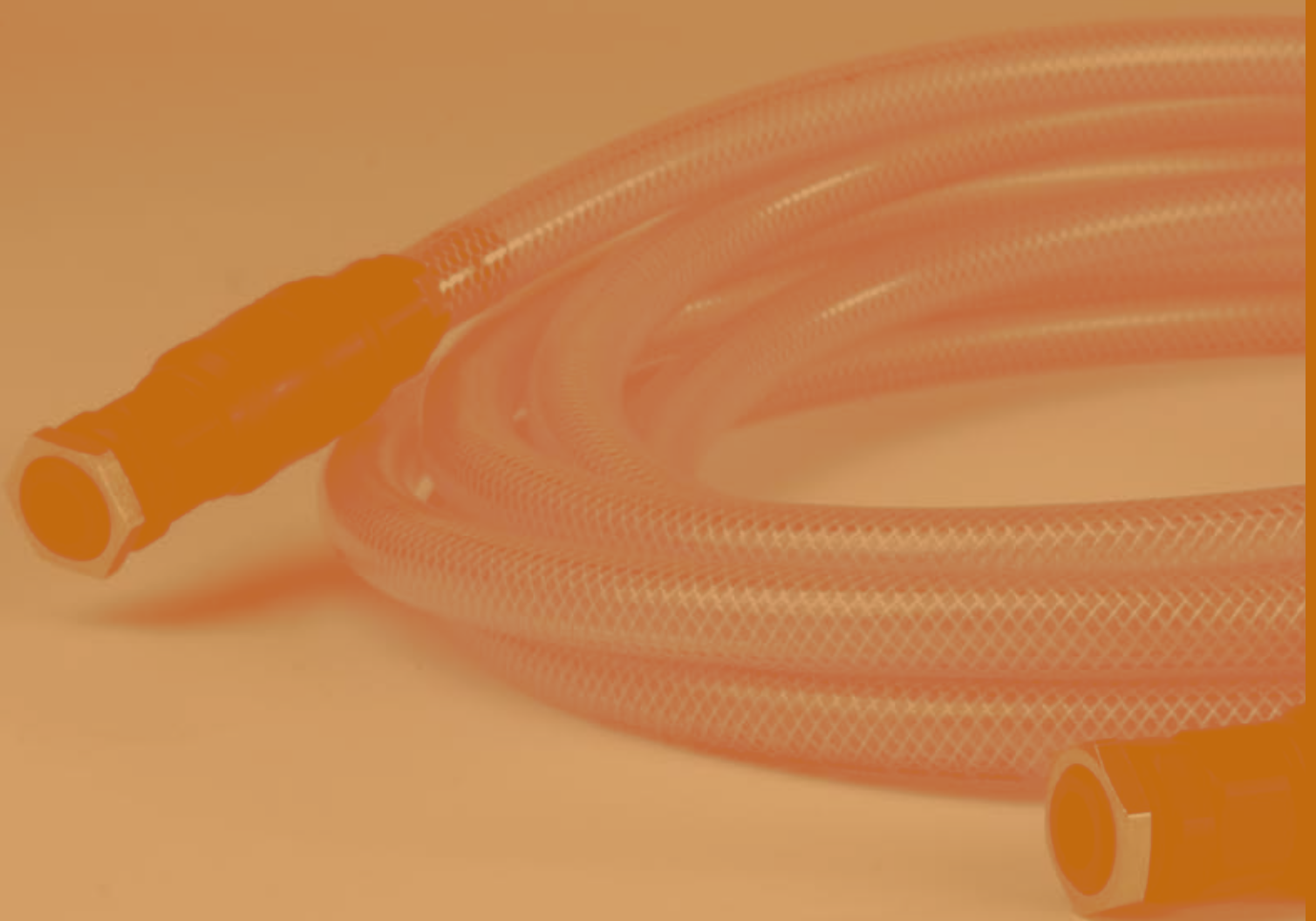

Of course you will receive all this in the usual SICCO high quality.



Shelves and Trays				
suitable for: Star-, Super-Star-, Protect-Star-, Black-Star, Thermo-Star-, Auto-Star-Desiccators				
Product description <i>Dimensions: width x height x depth</i>	Material / Special features	Weight	Cat.No:	
Shelf 258 x 4 x 320 mm; including 2 rails	PC, transparent rails made of polyamide	approx. 420 g including rails	V 1860-68	
Shelf 258 x 2 x 320 mm; with 12 bores Ø 10 mm including 2 rails	stainless steel, rails made of polyamide	approx. 1.305 g including rails	V 1860-52	
Collecting tray 235 x 80 x 320 mm max. collecting capacity 1,5 liter including 2 rails	welded stainless steel; max. all-over load: 12 kg; Collecting tray function: 20 mm height rails made of polyamide	approx. 1.200 g including rails	V 1952-16	
suitable for: Tower-Star-Desiccators				
Shelf 258 x 4 x 320 mm; including 2 rails	PC, transparent rails made of aluminium	approx. 420 g including rails	V 1860-67	
Shelf 258 x 2 x 320 mm; with 12 bores Ø 10 mm including 2 rails	stainless steel, usable up to 150 °C rails made of aluminium	approx. 1.305 g including rails	V 1860-51	
Collecting tray 235 x 80 x 320 mm max. collecting capacity 1,5 liter including 2 rails made of aluminium	welded stainless steel; max. all-over load: 12 kg; Collecting tray function: 20 mm height	approx. 1.200 g including rails	V 1952-08	
suitable for: Antistatic-Star-Desiccators				
Shelf 258 x 2 x 320 mm; including 2 rails	Aluminium	approx. 490 g including rails	V 1860-55	
suitable for: Star-Desiccators Double				
Shelf 565 x 0,5 x 320 mm; with 32 bores Ø 10 mm including 2 rails	stainless steel, rails made of polyamide	approx. 1350 g including rails	V 1860-61	

Shelves and Trays

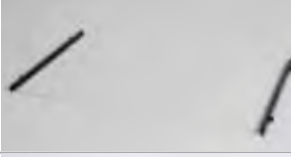

suitable for: Horizontal-Star-Desiccators

Product description Dimensions: Width x height x depth	Material / Special features	Weight	Cat.No.:	
Shelf 474 x 4 x 320 mm; including 2 rails	PMMA, transparent rails made of polyamide	approx. 735 g including rails	V 1860-73	
Shelf 474 x 4 x 320 mm; including 2 rails	Aluminium	approx. 1650 g including rails	V 1860-57	

suitable for: Vitrum-Star, Auto-Vitrum-Star-Desiccators

Shelf 258 x 2 x 320 mm; with 12 bores Ø 10 mm including 2 rails	stainless steel, usable up to 150 °C rails made of aluminium	approx. 1.305 g including rails	V 1860-51	
Collecting tray 235 x 80 x 320 mm max. collecting capacity 1,5 liter including 2 rails made of Aluminium	welded stainless steel; max. all-over load: 12 kg; Collecting tray function: 20 mm height	approx. 1.200 g including rails	V 1952-08	

suitable for: Mini-Desiccators

Shelf 211 x 2,0 x 178 mm	PMMA, transparent	approx. 90 g	V 1860-75	
Shelf 211 x 4,0 x 178 mm	PE static dissipative	approx. 149 g	V 1860-77	

suitable for: Vacuum-Desiccators



Shelf 258 x 5,0 x 250 mm	PMMA, transparent	approx. 380 g	V 1860-30	
------------------------------------	-------------------	---------------	------------------	---

suitable for: Maxi-1 Desiccator Horizontal

Shelf 1023 x 0,8 x 515 mm; including 2 rails	stainless steel, polyamide	approx. 3960 g	V 1860-05	
---	----------------------------	----------------	------------------	---

Shelves and Trays

suitable for: all Desiccators Big-Star, Maxi and Desiccator Wall



Product description <i>Dimensions: Width x height x depth</i>	Material / Special features	Weight	Cat.No.:	
Shelf 495 x 0,8 x 515 mm with 36 bores Ø 20 mm including 2 rails made of aluminium	stainless steel, usable up to 150 °C	approx. 1.800 g including rails	V 1860-02	
Collecting tray 472 x 120 x 515 mm including 2 rails made of aluminium max. collecting capacity 3,5 liter	welded stainless steel; max. all-over load: 30 kg; Collecting tray function: 15 mm height	approx. 3.300 g including rails	V 1951-08	
Collecting tray 472 x 180 x 515 mm including 2 rails made of aluminium max. collecting capacity 4,5 liter	welded stainless steel; max. all-over load: 30 kg; Collecting tray function: 20 mm height	approx. 4.100 g including rails	V 1951-16	

suitable for: Big-Star-Desiccators incl. Protect and Black, Auto-Big-Star-Desiccator, Super-Big-Star-Desiccator, Maxi-1/ -2-Desiccator incl. Protect and Black, Auto-Maxi-Desiccators, Super-Maxi-Desiccators, Desiccator Wall, Auto-Desiccator Wall

Shelf 495 x 0,8 x 515 mm with 36 bores Ø 20 mm including 2 rails	stainless steel, rails made of polyamide	approx. 1.800 g including rails	V 1860-03	
--	---	------------------------------------	------------------	---



Accessories for drying

suitable for: Mini-Desiccators

Silicagel with colour indicator from orange to dark brown and black, regenerative (does not contain cobalt-II-chloride) height x diametre 45 x 41 mm	Grain size 2,0–5,0 mm, loss after drying <= 4 %	23 g	V 1903-04	
Desiccant Cartridge Aluminium cartridge with encapsulated Silicagel, saturation is displayed on the top side by colour indicator from blue to pink.	width x height x depth 102 x 12 x 53 mm	40 g	V 1901-04	

Accessories for drying

suitable for: all Star-, Big-Star-, Maxi-Desiccators

Product description Dimensions: Width x height x depth	Material / Special features	Weight	Cat.No.:	
Silicagel with colour indicator from orange to dark brown and black, (does not contain cobalt-II-chloride), can be regenerated	Grain size 2,0–5,0 mm, loss after drying <= 4 %	360 g	V 1895-04	
		720 g	V 1895-08	
Silicagel with colour indicator from orange to dark brown and black, (does not contain cobalt-II-chloride), can be regenerated	Grain size 2,0–5,0 mm, loss after drying <= 4 %	8000 g	V 1895-12	
Desiccant Cylinder Aluminium cylinder with encapsulated Silicagel, saturation is displayed on the top side by colour indicator from blue to pink.	height x diameter 136 x 108 mm	750 g	V 1902-04	

suitable for: all Desiccators for gas-filling

PVC hose for introduction of gas including two quick couplings made of POM and non-return valve.	PVC Fibre hose I.D. 9 mm x O.D. 15 mm	5 m length	V 1864-01	
---	--	------------	------------------	---

suitable for: all Desiccators

Tray for Silicagel 247 x 30 x 297 mm for 1000 g Silicagel	PBTP	365 g	V 1861-07	
--	------	-------	------------------	---

Hygrometer				
suitable for: Mini-Desiccators				
Product description Dimensions: Width x height x depth	Material / Special features	Weight	Cat.No.:	
<p>Electronic Thermo-Hygrometer with max-min function; 52 x 39 x 15 mm; including LR 44 button cell, fastener and fastening screws</p>	<p>Measuring ranges: Temperature: -10 to +60 °C Humidity: 10-99 % r.h.. Max. measuring error: ± 1 °C at -10 to +50 °C ± 5 % r.h. at 25-75 % r.h. and 0-50 °C</p>	30 g	V 1863-05	
suitable for: Star-, Big-Star-, Maxi-Desiccators				
<p>Electronic Thermo-Hygrometer with max-min function; 52 x 39 x 15 mm; including LR 44 button cell, fastener and fastening screws</p>	<p>Measuring ranges: Temperature: -10 to +60 °C Humidity: 10-99 % r.h.. Max. measuring error: ± 1 °C at -10 to +50 °C ± 5 % r.h. at 25-75 % r.h. and 0-50 °C</p>	30 g	V 1863-07	
<p>Electronic Thermo-Hygrometer with max-min function; large display 110 x 95 x 20 mm; including battery 1,5 V AAA, fastening material</p>	<p>Measuring ranges: Temperature: -10 to +60 °C Humidity: 10-99 % r.h.. Max. measuring error: ± 1 °C at -10 to +50 °C ± 5 % r.h. at 25-75 % r.h. and 0-50 °C</p>	171 g	V 1866-07	
<p>Electronic Thermo-Hygrometer with max-min function; 120 x 89 x 40 mm; including battery, calibration report resolution 0,1% rF / 0,1 °C, measuring cycle 18 seconds</p>	<p>Measuring ranges: Temperature: -10 to +70 °C, ± 0,5 °C Humidity: +2 to 98 % rh, ± 2 % Dew point: -40 to +70 °C td Durability: 8736 h</p>	168 g	V 1859-08	
suitable for: all Desiccators				
<p>Mini-Hygrometer 68 x 45 x 25 mm; Digital LED display, including two batteries 1,5 V AAA</p>	<p>Measuring ranges: Temperature: 0 to +50 °C Humidity: 1 - 99% rh Max. measuring error: ± 1°C at 25°C ± 3% rh at 1% - 80% Resolution: 1% rF / 1 °C Sensor drift: 1% rh and 0,2 °C in 4 years</p>	65 g	V 1829-08	

Humidity-Temperature Probe with USB-Interface

suitable for: all Desiccators

Product description Dimensions: Width x height x depth	Material / Special features	Weight	Cat.No.:	
<p>Combined temperature and humidity probe which can be directly driven by PC by means of USB interface in handle, wide measuring range, high resolution, very good linearity and durability, calculation and indication of dew point, absolute humidity vapor pressure, saturated vapor pressure and enthalpy, tabulated measured values, data are recorded on hard disk, humidity is measured with a long-term stable, capacitive polymer sensor, for monitoring store rooms in food production industry, quality control or HVAC technology, humidity measuring systems for custom projects, microcontroller applications, for Windows or Linux.</p>				
<p>Combined temperature and humidity probe including carry case and Windows-software for measured value display and data recording as well as USB plug type A, 1.1 or 2.0 compatible</p>	<p>Dim. of stainless steel tube Ø 12 x 125 mm and sintering filter, Measuring range: 0-100% rh, ± 2 % and -40 to 80 °C, ± 0,5 K Humidity: 0,01% rh Temperature: 0,01 K</p>	100 g	V 1868-08	

USB-Datalogger

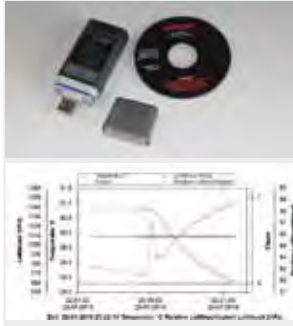

suitable for: all Desiccators

Battery-driven data logger with integrated temperature and humidity sensor. The measured data are recorded automatically in adjustable sampling rates of 1 minute to 24 hours. The device can save max. 40.020 values (20.010 humidity values and 20.010 temperature values). The stored data can be immediately read on the LC display. It is connected to a computer as a USB stick and read out there. A graphic report in PDF format is automatically generated.



<p>USB-Datalogger Scope of delivery: Datalogger with protecting cap, 3V button cell (CR2450), Software CD, Installation manual</p> <p>Dimensions: approx. 40 x 90 x 20 mm Measuring interval: from 1 minute to 24 hours</p> <p>Battery life time: approx. 1 year at sampling rate 1 time per minute Connection type: USB 2.0</p>	<p>Temperature measuring range: -30 to +60 °C</p> <p>Temperature accuracy: +/- 0,5 °C / > 0 to 60 °C, +/- 1 °C / -30 to 0 °C</p> <p>Humidity measuring range: 0-100 % rh</p> <p>Humidity accuracy: +/- 5% (0-20 %, 80-100 %) +/- 3,5% (>20-40 %, 60-80 %) +/- 3 % (>40 - <60 %)</p> <p>Resolution: 0,1 °C / 0,1 % rh</p>	20 g	V 1869-08	
---	--	------	------------------	---

Accessories for Maintenance and Wall Fastening

suitable for: Star-Desiccators

Product description Dimensions: Width x Height x Depth	Material / Special features	Weight	Cat.No.:	
<p>Maintenance Kit for Star Desiccators Easy exchange of sealing and magnetic tape to ensure the airtight closure of the desiccator.</p>	<p>consisting of a rubber sealing tape, a magnetic tape and rubber feet</p>	125 g	V 1778-02	
<p>Connectors for Desiccators (except of Thermo-Star) (20 x 60 x 10 mm) Consisting of four pairs of braces, each pair with one screw and nut, one hexagon wrench, operating instruction</p>	Aluminium	approx. 100 g	V 1953-07	
<p>Wall Fastening Kit for Star Desiccators (except of Auto- and Thermo-Star) (20 x 60 x 10 mm) Consisting of one pair of wall-rails, one pair of fastening rails, six cylinder screws and one hexagon wrench. Screws for fixation of the rails on your wall are not included. More information on page 95.</p>	Aluminium	approx. 650 g	V 1777-05	

suitable for: Big-Star-, Maxi-Desiccators

<p>Maintenance Kit for Big-Star-/Maxi-Desiccators Easy exchange of sealing and magnetic tape to ensure the airtight closure of the desiccator.</p>	<p>consisting of a rubber sealing tape, a magnetic tape and rubber feet</p>	225 g	V 1779-02	
<p>Connectors for Desiccators (20 x 60 x 10 mm) Consisting of four pairs of braces, each pair with one screw and nut, four silicone o-rings, one hexagon wrench, operating instruction. More information on page 95.</p>	<p>Aluminium Rubber feet and casters have to be disassembled from the upper desiccator. The provided silicone o-rings avoid a slipping of the desiccators.</p>	approx. 110 g	V 1954-07	

Accessories for Glove Boxes

suitable for: Glove Boxes

Product description Dimensions: Width x Height x Depth	Material / Special features	Weight	Cat.No.:	
<p>Protective tray 828 x 26 x 528 mm</p>	<p>stainless steel, welded, additional protection for the base panel of the glove box; collecting tray function: approx. 20 mm height / 10 liters</p>	3500 g	V 1971-07	
<p>Gloves natural rubber, mutually wearable, suitable for holes of Ø 190 mm; perforation- and abrasion-proof, high flexibili- ty, low voltage value, low electrostatic charging; Length 750 mm</p>	<p>Size 7 Size 8 Size 9</p>		<p>V 1972-07 V 1972-08 V 1972-09</p>	
<p>Gloves EPDM conductive black, mutually wearable, suitable for holes of Ø 190 mm, perforation- and abrasion-proof, high flexibility, low voltage value; electroconductive 10⁵ ohm, Length 800 mm</p>	<p>Size 9,75</p>		V 1974-09	
<p>Gas-saving valve for direct assembly to the cable lead-in of a SICCO Glove Box. With hose connector for aeration tubing with inner Ø 45 mm. The pass to the aeration tubing is closed nearly gas-tightly through a plastic ball and opens automatically for pressure compensation in case of overpressure or vacuum inside the glove box. This way, no ambient air can enter the glove box through the aeration tubing and thus, gas consumption is reduced during working and scavenging process inside the glove box. Take care of the correct mounting position, additional required space: approx. 130 mm. Including one hexagonal wrench and four fixing screws. More information on functionality and assembly on page 100.</p>				
75 x 120 x 130 mm	polypropylene	155 g	V 1787-07	
<p>Iris-Ports with o-ring sealing (silicone) and two slotted discs (silicone). The overlapping segments of the crosswise slotted silicone discs allow at the same time easy access to the interior space and close the port openings when the glove box is not in use. The Iris-Ports can easily be mounted on all SICCO Glove Boxes instead of the standard gloves. Scope of delivery: 1 pair. More information on page 101.</p>				
<p>Ø 215 mm x H 40 mm Scope of delivery: 1 pair</p>	polyethylene, silicone	385 g	V 1976-07	

Accessories for Glove Boxes				
suitable for: Glove Boxes				
Product description Dimensions: Width x Height x Depth	Material / Special features	Weight	Cat.No.:	
Closing lid with cord seal. Protection against contamination (such as dust particles in the ambient air) through easy pushing on the glove port of your SICCO Glove Box. The sealing included in the scope of delivery provides safe grip of the closing lid on the glove port, the lid is not gastight. Included in the scope of delivery: 1 closing lid and 1 cord seal. More information on page 101.				
Ø 215 mm x H 30 mm	polyethylene, silicone	195 g	V 1790-07	
Cable lead-in with sleeve nut, components made of PP natural; slotted plug of black silicone for tight fastening. Including hexagon wrench and fastening screws. For lead-in cables or hard-walled tubing from OD 0,1 to max. 10 mm. Installation in panels with thickness 2-4 mm, Bore Ø 74,5 mm.				
Inner Height x Outer Height x Diameter 36 x 4 x 86 mm	polypropylene, silicone	185 g	V 1782-07	
Cable lead-in antistatic with sleeve nut, components made of PE black conductive; slotted plug of black silicone for tight fastening. Including hexagon wrench and fastening screws. For lead-in cables or hard-walled tubing from OD 0,1 to max. 10 mm. Installation in panels with thickness 2-4 mm, Bore Ø 74,5 mm.				
Inside height x Outside height x Diameter 36 x 4 x 86 mm	polyethylene-ESD, silicone	185 g	V 1783-07	
Cable lead-in Iris-Port Cable lead-in Iris-Port, components made of PP natural, two crosswise slotted, staggered mounted discs of silicone. For direct lead-in of cables and tubes up to an OD 40 mm. Installation in panels with thickness 2-4 mm, Bore Ø 74,5 mm.				
Inside height x Outside height x Diameter 27 x 4 x 86 mm	polypropylene, silicone	110 g	V 1789-07	
Connecting kit for gas-filling consisting of two discs with hose connectors of PP natural, 5 m PVC tubing for gas-filling ID 9 mm and 5 m PE aeration tubing ID 45 mm, including hexagon wrench and fastening screws.				
PVC tubing for gas-filling Inner Diameter 9 mm PE aeration tubing Inner Diameter 45 mm	polypropylene	1985 g	V 1785-07	



On the following pages you will find helpful information on our SICCO Desiccators and Glove Boxes.

Performance at a glance.

DRYING PERFORMANCE Desiccators for drying/storage

Test procedure:

A relative humidity of approx. 100 % is simulated in a desiccator. In the bottom of the desiccator there is a tray with 500 g of Silicagel. The door is closed and is airtight. The curves show relative humidity versus time.

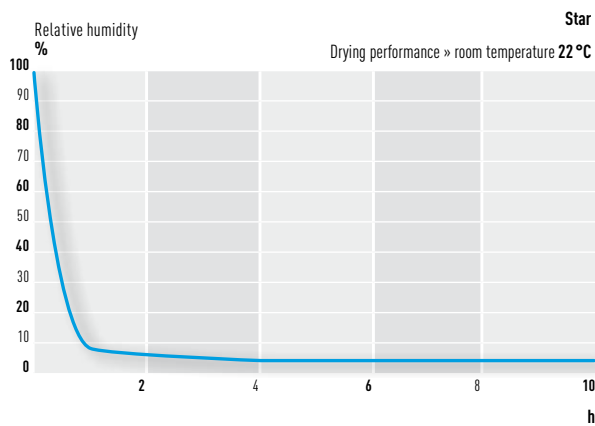

Relative humidity of below 10 % after approx. one hour.



Relative humidity of below 10 % after almost two hours.

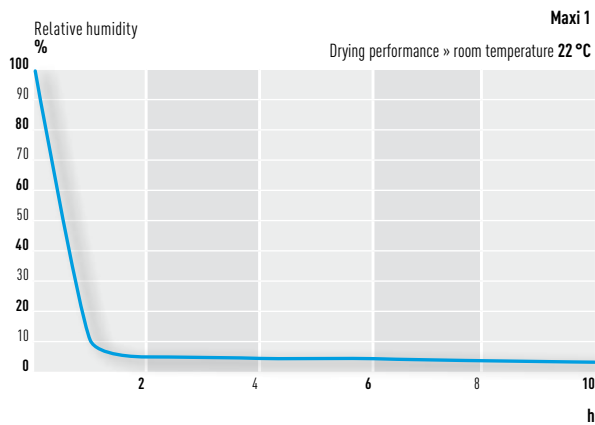

Relative humidity of below 10 % after little more than one hour.

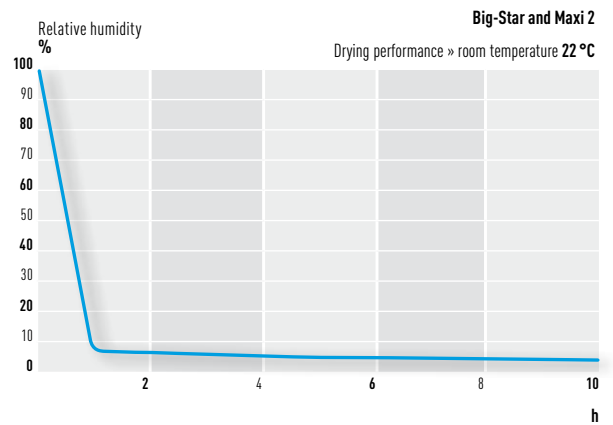

Relative humidity of below 10 % after approx. one hour.

OPENING AND CLOSING THE DOOR

Test procedure:

A desiccator with three shelves is loaded with approx. 30 beakers. A relative humidity of max. 7% is maintained inside the desiccator. On one shelf and at the bottom of the desiccator there is one tray (350 x 240 mm) with 500 g of silica gel.

Then the airtight door is opened for 10 seconds and then closed. The curves show the development of humidity.

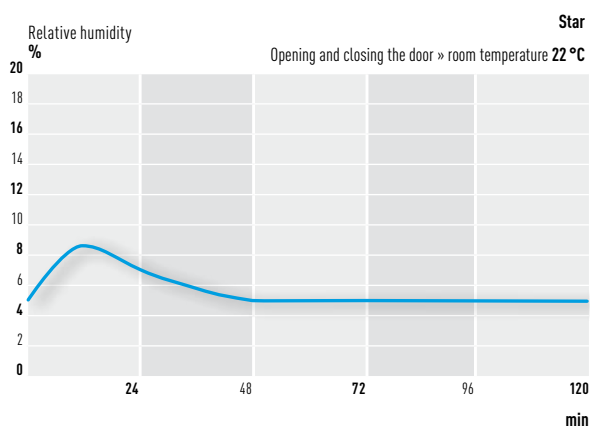

The initial value is attained after approx. 48 minutes.

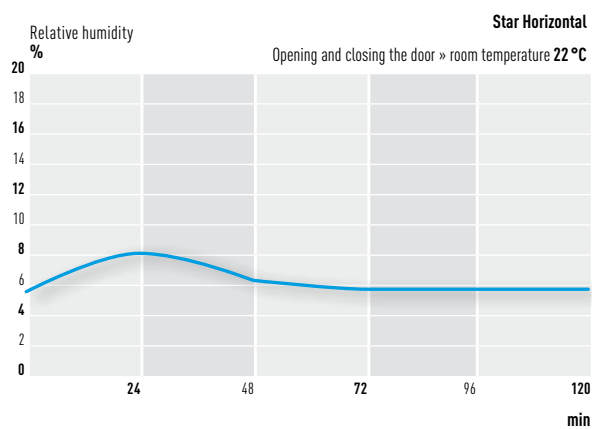

The initial value is attained after approx. 58 minutes.

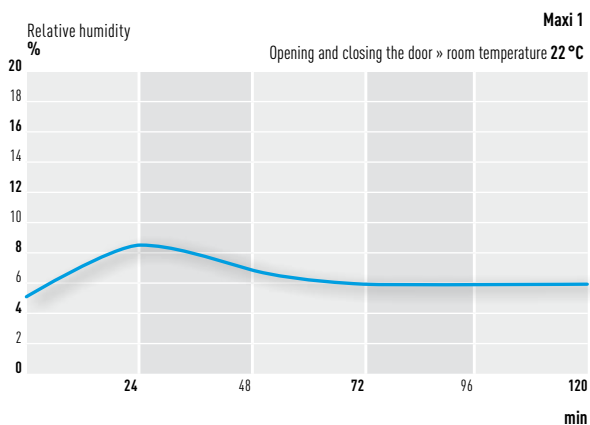

The initial value is attained after approx. 72 minutes.

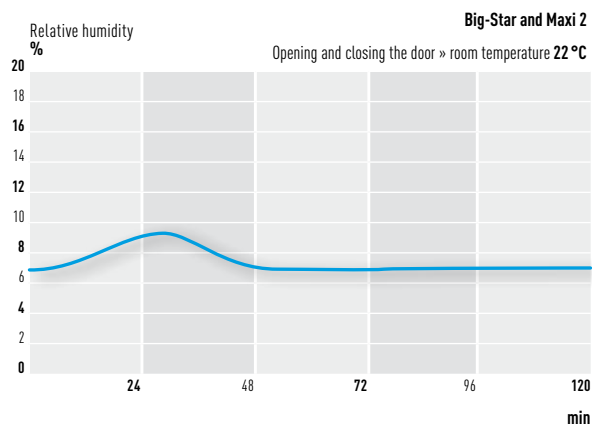

The initial value is attained after approx. 48 minutes.

Performance at a glance.

DRYING PERFORMANCE Automatic-Desiccators

Test procedure:

After a pre drying period of 10 minutes, a humidity of 100 % is simulated in an Automatic-Desiccator. The desiccator is switched on, the door remains closed tightly until the end of the test. The curves show relative humidity versus time.

Results:

After only 10 hours, the relative humidity inside the desiccator is down to 10 % due to automatic drying. Frequent controls are not necessary. The storage space is bigger since it is not necessary to use silica gel and process errors are avoided.

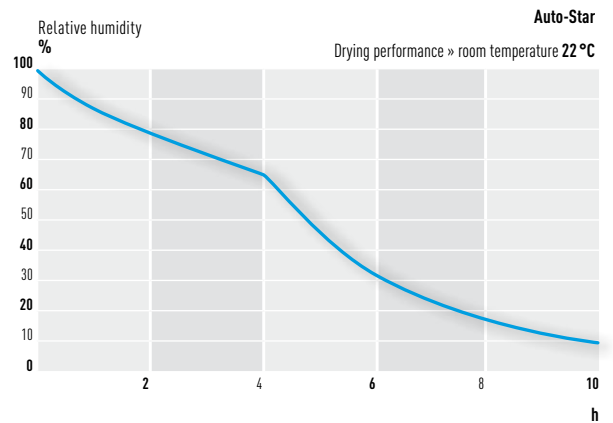

Relative humidity of below 30 % after little more than 6 hours

OPENING AND CLOSING THE DOOR

Test procedure:

An Automatic-Desiccator with three shelves is loaded with six bottles of 1.5 litres capacity on the two lower shelves. In addition, there are 12 beakers on the upper shelf. A relative humidity of 13% is produced in the desiccator. The airtight door is opened for 10 seconds and closed. The curves show the relative humidity versus time.

Results:

The humidity falls to the initial value of 13 % after a short period of time. Application errors that may occur with silica gel are avoided.

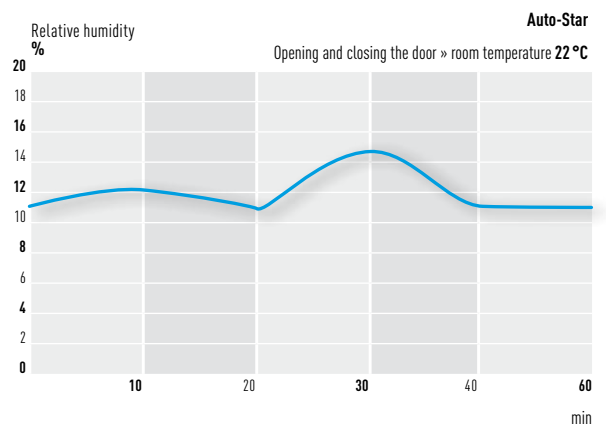

The initial value is attained after approx. 40 minutes.

INTERRUPTION OF POWER SUPPLY

Test procedure:

An Automatic-Desiccator with three shelves is loaded with six bottles of 1.5 litres capacity on the two lower shelves. In addition, there are 12 beakers on the upper shelf. A relative humidity of 13 % is produced in the desiccator. Then the desiccator is switched off at a room temperature of 22 °C. The curves show relative humidity versus time.

Results:

A significant increase of humidity is only noticeable after several hours. This means that the contents of the desiccator remain safe even if the power supply is interrupted.

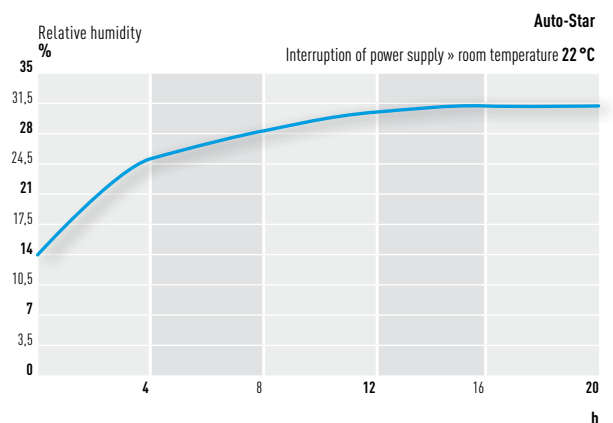

Only 15 % of increase within 20 hours.



Relative humidity of below 30 % after little more than 3,5 hours.

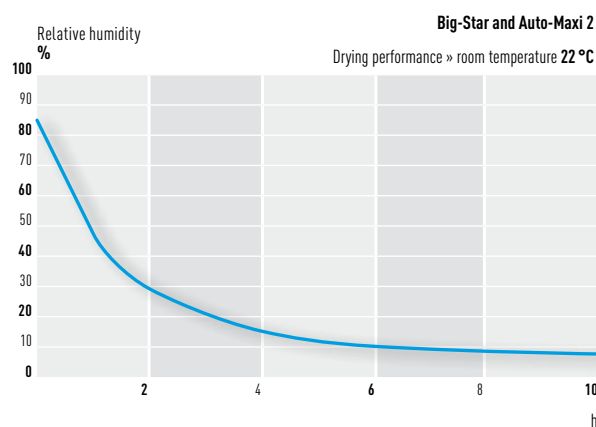

Relative humidity of below 30 % after approx. 2 hours

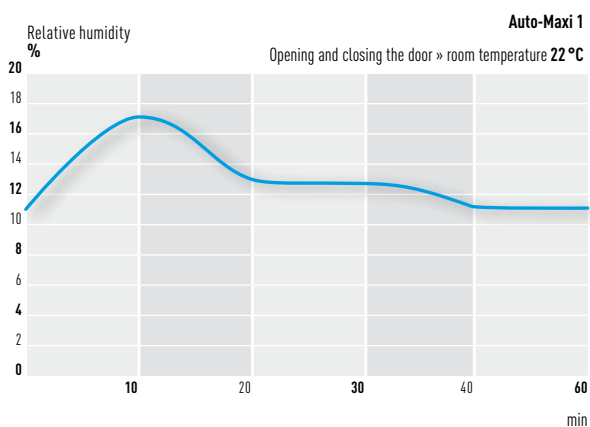

The initial value is attained after approx. 40 minutes

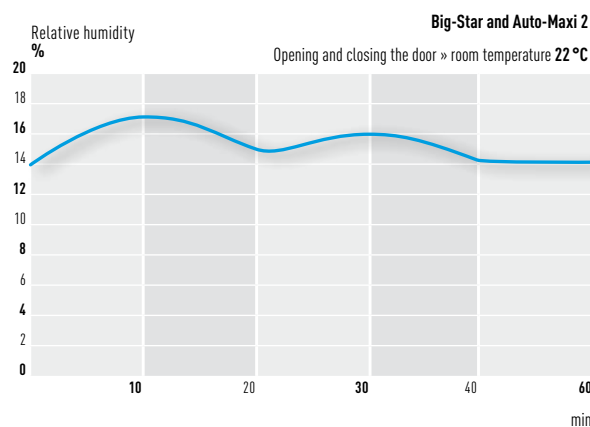

The initial value is attained after approx. 40 minutes

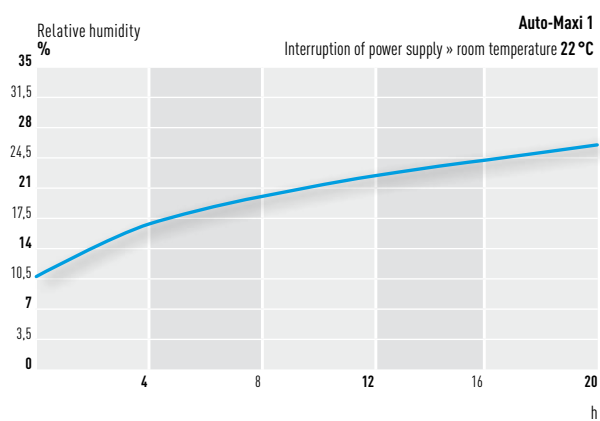

Only 18 % of increase within 20 hours

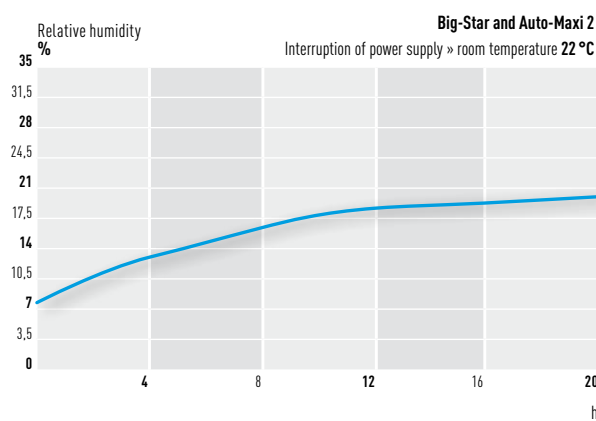

Only 15 % of increase within 20 hours.

Performance at a glance.

DRYING PERFORMANCE Desiccators for gas-filling

Test procedure:

A relative humidity of 100 % is simulated in a desiccator for gas-filling. A SICCO Gas Dosing Controller is connected during the lead in of nitrogen in order to control the gas supply and monitor the relative humidity. The attainable required humidity is adjusted to 10 %, the flow rate to 8 Liters / minute and the pressure reducer on the nitrogen bottle to 0,5 bar. The door remains closed tightly until the end of the test. The curves show the relative humidity versus time.

Results:

The moist air inside the desiccator is displaced by nitrogen with low humidity and thus the required relative humidity is reached in a very short period of time.

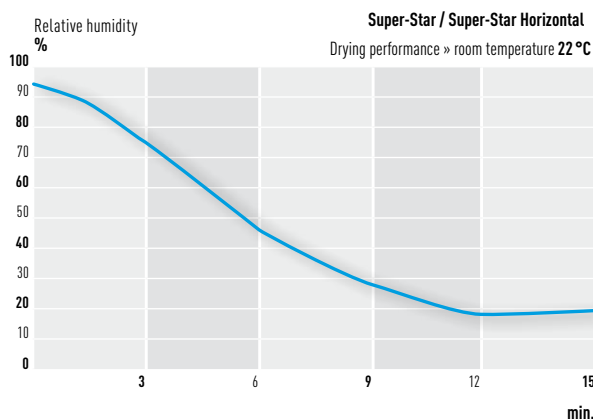

Relative humidity of below 15 % after approx. 15 minutes.

OPENING AND CLOSING THE DOOR

Test procedure:

Due to the constant gassing with nitrogen the relative humidity inside a desiccator is 15 %. A SICCO Gas Dosing Controller is connected during the lead in of nitrogen in order to control the gas supply and monitor the relative humidity. The attainable required humidity is adjusted to 10 %, the flow rate to 8 Liters / minute and the pressure reducer on the nitrogen bottle to 0,5 bar. The door of the desiccator is opened completely for 30 seconds. The curves show the relative humidity versus time.

Results:

The opened door causes an air exchange and thus the relative humidity inside rapidly increases. By closing the door the gas dosing controller starts working again and the work space is purged again with nitrogen. After approx. 30 minutes the initial value is reached again:

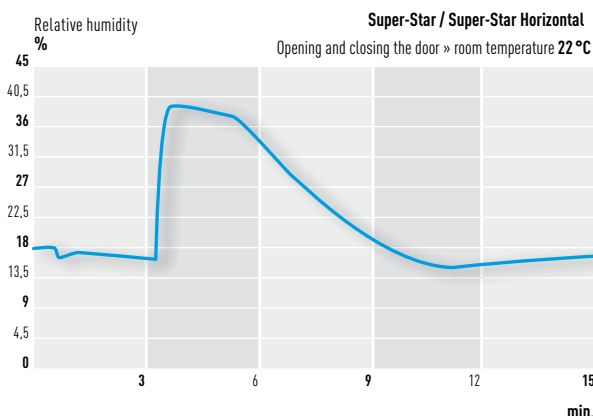

The initial value is attained after approx. 10 minutes.

INTERRUPTION OF GAS SUPPLY

Test procedure:

Due to the constant gassing with nitrogen the relative humidity inside a desiccator is 15 %. A SICCO Gas Dosing Controller is connected during the lead in of nitrogen in order to control the gas supply and monitor the relative humidity. The attainable required humidity is adjusted to 10 %, the flow rate to 8 Liters / minute and the pressure reducer on the nitrogen bottle to 0,5 bar. The Gas Dosing Controller is turned off to interrupt the gas supply. The desiccator remains closed tightly until the end of the test. The curves show the relative humidity versus time.

Results:

Despite the missing gas supply the relative humidity inside the desiccator is only proportionally increasing slowly.

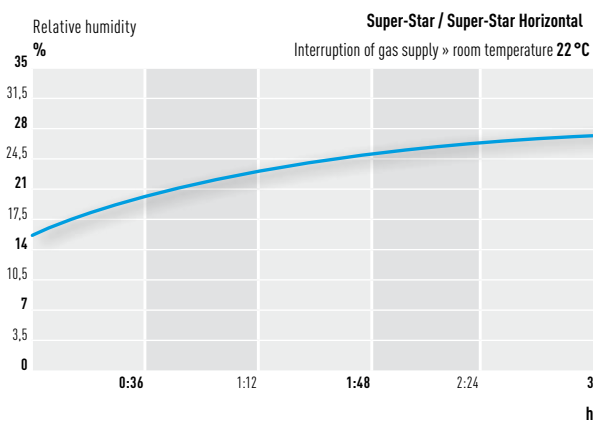

Only 10 % of increase within 3 hours.

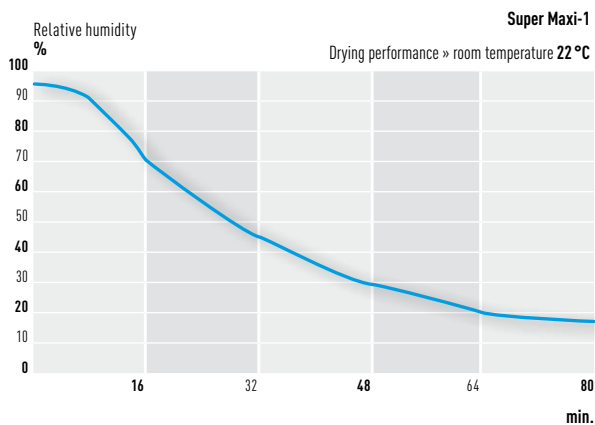

Relative humidity of below 15 % after approx. 65 minutes.

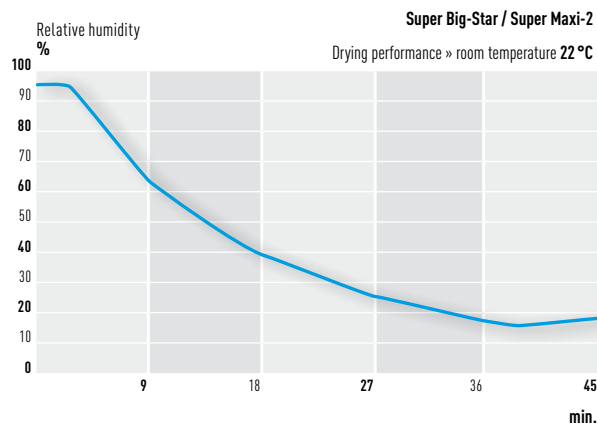

Relative humidity of below 30 % after approx. 45 minutes.

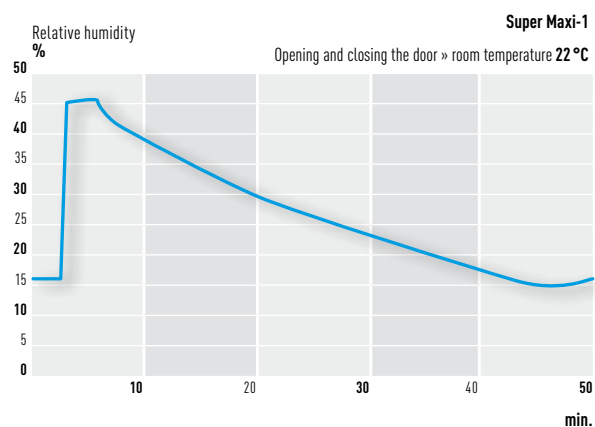

The initial value is attained after approx. 40 minutes.

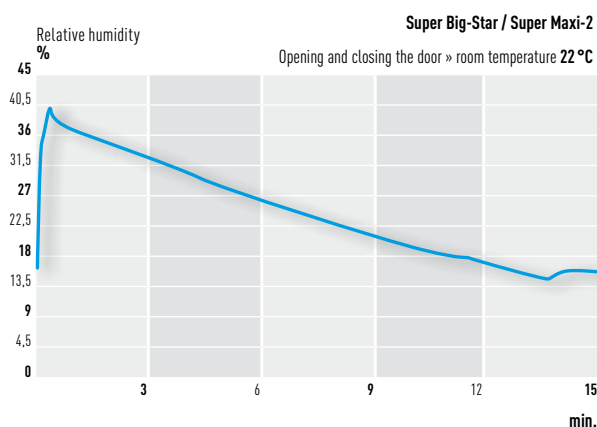

The initial value is attained after approx. 20 minutes.

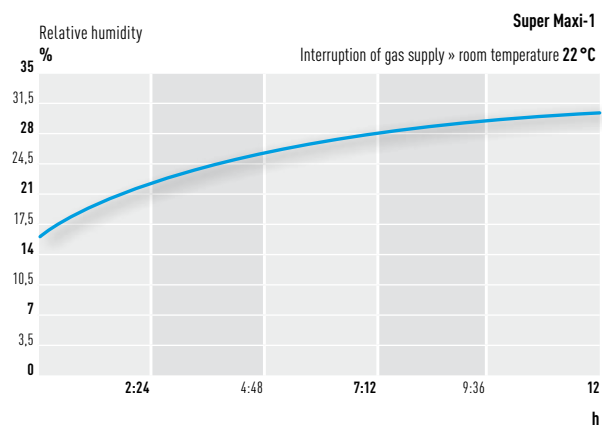

Only 10 % of increase within 10 hours.

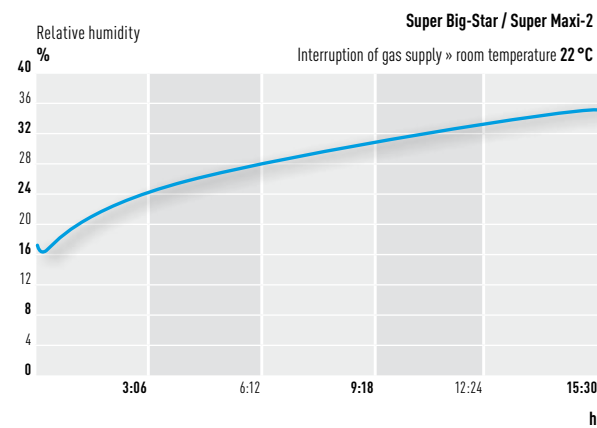

Only 10 % of increase within 4 hours.

Performance at a glance.

DRYING PERFORMANCE Glove Box

Test procedure:

A relative humidity of 100 % is simulated in a glove box. A SICCO Gas Dosing Controller is connected during the lead in of nitrogen in order to control the gas supply. A SICCO Gas-saving Valve is connected to the outlet for aeration. In the Gas Dosing Controller, the attainable required humidity is adjusted to 10 %, the flow rate to 8 Liters / minute and the pressure reducer on the nitrogen bottle to 0,5 bar. The glove box and transfer chamber remain closed tightly until the end of the test. The curve shows the relative humidity versus time.

Results:

After approximately one hour, a relative humidity of 15 % is reached inside the glove box because of the supply of nitrogen. It is assumed that using a Gas Dosing Controller during the lead in of gas, the relative humidity decreases by 1% per minute at a flow rate of 8 Liters / minute.

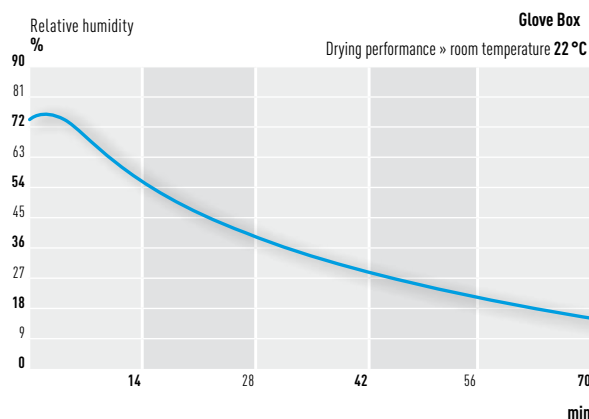

Relative humidity of below 15 % after approx. 15 minutes.

OPENING AND CLOSING THE DOOR

Test procedure:

Due to the constant gassing with nitrogen the relative humidity inside a glove box with transfer chamber is 15 %. A SICCO Gas Dosing Controller is connected during the lead in of nitrogen in order to control the gas supply. A SICCO Gas-saving Valve is connected to the outlet for aeration. In the Gas Dosing Controller, the attainable required humidity is adjusted to 10 %, the flow rate to 8 Liters / minute and the pressure reducer on the nitrogen bottle to 0,5 bar. The door of the working space is opened completely for 30 seconds, the transfer chamber is closed tightly during the test procedure. The curves show the relative humidity versus time.

Results:

The opened door causes an air exchange and thus the relative humidity inside rapidly increases to approx. 50 %. By closing the door the gas dosing controller starts working again and the work space is purged again with nitrogen. After approx. 30 minutes the initial value is reached again.

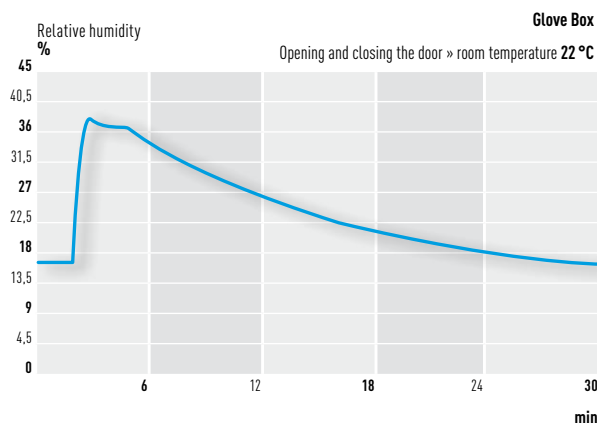

The initial value is attained after approx. 30 minutes.

Performance at a glance.

OPENING AND CLOSING THE TRANSFER CHAMBER

Test procedure:

Due to the constant gassing with nitrogen the relative humidity inside a glove box with transfer chamber is 15 %. A SICCO Gas Dosing Controller is connected during the lead in of nitrogen in order to control the gas supply. A SICCO Gas-saving Valve is connected to the outlet for aeration. In the Gas Dosing Controller, the attainable required humidity is adjusted to 10 %, the flow rate to 8 Liters / minute and the pressure reducer on the nitrogen bottle to 0,5 bar. The transfer chamber is not purged with gas. The relative humidity inside the transfer chamber is 47 % at the beginning of the test procedure. The door of the transfer chamber in direction of the workspace is opened completely for 30 seconds. The curves show the relative humidity versus time.

Results:

Due to the opened door of the transfer chamber in direction of the workspace the relative humidity inside increases slightly to approx. 20 %. After approx. 10 minutes the initial value is reached again by re-supply of gas.

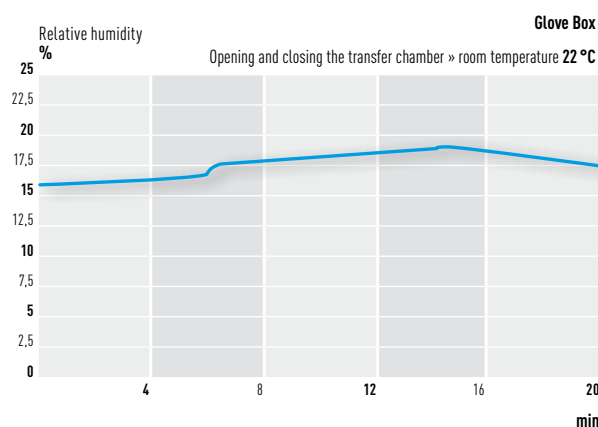

The initial value is attained after approx. 10 minutes.

INTERRUPTION OF GAS SUPPLY

Test procedure:

Due to the constant gassing with nitrogen the relative humidity inside a glove box with transfer chamber is 15 %. A SICCO Gas Dosing Controller is connected during the lead in of nitrogen in order to control the gas supply and monitor the relative humidity. The attainable required humidity is adjusted to 10 %, the flow rate to 8 Liters / minute and the pressure reducer on the nitrogen bottle to 0,5 bar. The Gas Dosing Controller is turned off to interrupt the gas supply. The glove box and the transfer chamber remain closed tightly until the end of the test. The curves show the relative humidity versus time.

Results:

Through the aeration tubing, there is a slight air exchange despite the Gas-saving Valve. After approx. 1 hour, the relative humidity is approx. 20%, after more than 14 hours the relative humidity is at the same level as the ambient air. Despite the short-term missing power supply, the atmosphere inside the workspace of the glove box is only slightly influenced.

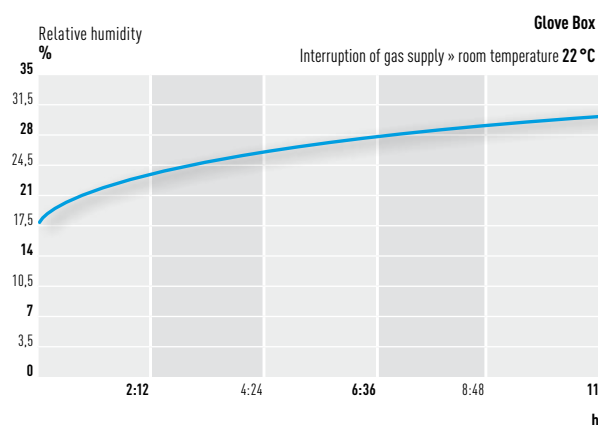

Only 10 % of increase within 8 hours.

Effective and utility space

By means of the following chart you can easily determine the utility space per shelf and if this is enough for the planned products.

When choosing the number of shelves, please consider as well the maximum all-over load per shelf as well as the total all-over load of the desiccators that must not be exceeded.

A = Clear opening between two shelves / assembly in consecutive rasters in mm

R = Distance between two consecutive rasters in mm

B = Usable width of the shelf in mm

T = Usable depth of the shelf in mm

H = Thickness of the shelf in mm

Unless you do not mount a shelf in every raster, calculate the clear opening between two shelves as follows:

Clear opening A = number of rasters x R - H

e. g. in Star Desiccators and a distance of 6 rasters:

$A = 6 \times 17,5 - 6 \text{ mm} = 99 \text{ mm}$

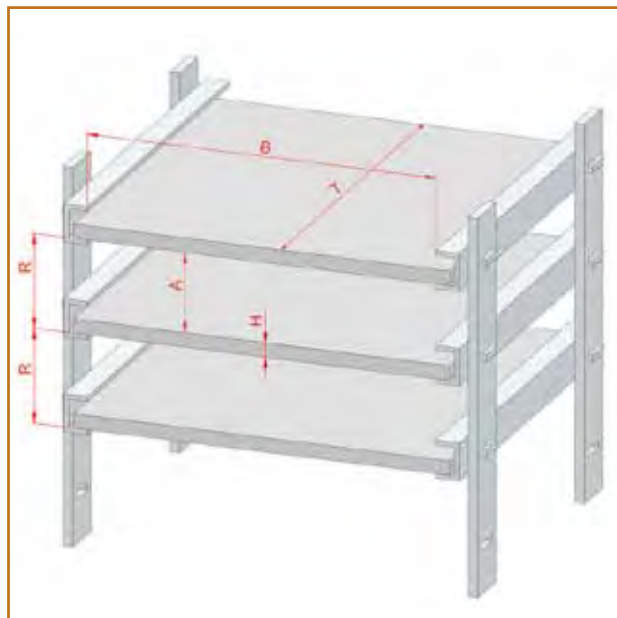

Clear opening between two shelves / assembly in consecutive rasters in mm	Distance between two consecutive rasters in mm	Usable width of the shelf in mm	Usable depth of the shelf in mm	Thickness of the shelf in mm
A	R	B	T	H
Star-, Protect-Star-, Black-Star-, Thermo-Star-, Tower-Star-, Super-Star-, Auto-Star-Desiccators				
12	17,5	245	320	6
Star-Vitrum-, Antistatic-Star-, Super-Star-Vitrum-, Auto-Star-Vitrum-Desiccators				
16	17,5	245	320	2
Horizontal-Star-, Horizontal-Star-Vitrum-Desiccators				
14	17,5	461	320	4
Star-Desiccator Double				
7,5	17,5	550	320	10
Desiccators-Wall, Auto-Desiccators-Wall, all Big-Star-, and Maxi-1/-2-Desiccators except for models Vitrum und Antistatic.				
47	60	479	515	13
Desiccator-Wall Antistatic, Big-Star-Vitrum, Maxi-1/-2-Vitrum, Big-Star-Antistatic, Maxi-1/2-Antistatic				
17	30	479	515	13
Maxi-1-Horizontal-Desiccator				
47	60	1006	515	13

Effective and utility space

Clear opening between two shelves / assembly in consecutive rasters in mm A	Distance between two consecutive rasters in mm R	Usable width of the shelf in mm B	Usable depth of the shelf in mm T	Thickness of the shelf in mm H
Dolly-Dessicator				
17	30	527	365	13
Big-Star-Dessicator Low				
47	30	478	515	13
All Mini-Dessicators Basic, all Mini-Dessicators Premium				
54	56	211	178	2
Mini-Vitrum				
83	-	200	182	1,5
Vakuu-1, Vakuu-2-Dessicator				
55	60	258	230	5
Vakuu-3-Dessicator				
50	55	258	230	5

Cleaning of Desiccators

For correct cleaning, use a soft cloth or a sponge (no microfiber) so that the panels will not get scratches. Glass cleaner or pH-neutral cleaner have proved its worth. There are also special antistatic plastic cleaner and caring products that avoid the electric static charging of the panels. Thereby less dust and floating particles are energized. Do not use cleaner with acetone, benzol or carbon tetrachloride. These substances damage the surface by softening or blurring it.



Suspension arrangements and Rails

With the numbered suspension arrangements and rails of the SICCO Star Desiccators you can easily and quickly position your shelves. You will not have to test until the shelves have found their horizontal position. The consecutive numeration on the rail system helps in addition for the documentation of your experiment.



Safe stacking of Desiccators

SICCO Connectors for desiccators allow a fix connection of stacked drying cabinets, no matter if you want to stack two desiccators of the size Star, Big-Star or Maxi.

On each side a pair of braces will be clipped to the upper and lower device respectively on the front and back of the frame (1). By means of a hexagon socket head cap screw (2) and the appropriate hexagon wrench the braces will be safely fixed, the upper desiccator is secured against tilting and slipping.

Due to its construction, the connectors can be mounted later at any time effortlessly. Only for Big-Star and Maxi-Desiccators the non-slip rubber feet respectively the casters have to be removed from the upper device. Nonetheless this doesn't require great mechanical skills.

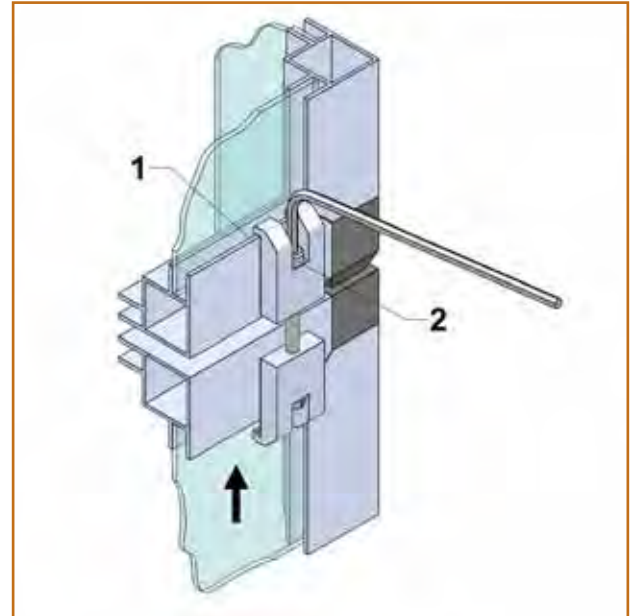

Safe wall fastening

In order to use the available space of your work station efficiently there is an appropriate Wall Fastening Kit for Star-Desiccators. With this kit you can hang up your Star-Desiccator without great technical effort.

The Wall Fastening Kit provides you with all necessary parts to fasten your Star-Desiccator on the wall: one pair of wall-rails, one pair of fastening rails, six cylinder screws and one hexagon wrench. Depending on the quality of the chosen wall (e.g. plasterboard or masonry) you just have to buy the appropriate screws and if necessary anchor bolts.

You don't need to take measurements to find the best position for your desiccator. You can simply use our drilling template in the scale 1:1. Once you found the best position the drilling template can be fixed to the wall. Then you can already mark the position of the bores for the wall-rails directly on the wall and mount the rails.

The fastening rails are hooked on the wall-sided, upper frame of the desiccator and are screwed together. Afterwards the desiccator with the assembled fastening rail can be connected with the upper wall-rail. With two further screws the hanger assembly is secured against slipping.

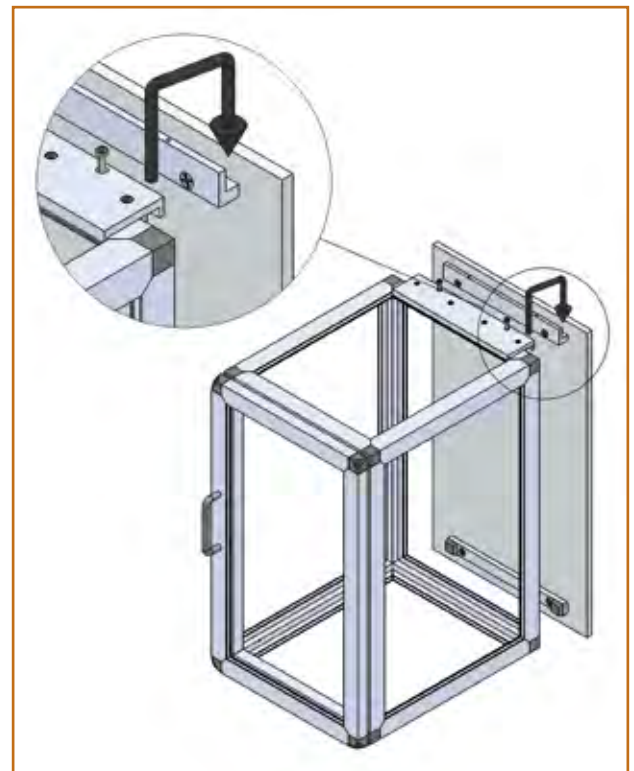

Proper use of desiccant

The humidity in your desiccator can be reduced most rapidly if you spread it on a big surface. The provided desiccant tray is best suitable for it. Please make sure that the desiccant surface is not higher than one centimeter. If you have to increase the desiccant quantity for your experiment, please take another tray.

Up to 16 g humidity can be absorbed by the SICCO desiccant within 24 hours.



Regeneration of Silicagel

Silicagel has a color-indicator that shows the rate of saturation of the desiccant. Orange means dried and absorptive, dark brown to black means saturated. To regenerate the desiccant, put it into the oven at 90-110°C together with the provided tray for 90 minutes. A microwave is unsuitable for this. You have to calculate 90 minutes for regeneration per centimeter filling height. Overheated desiccant is destroyed and cannot be regenerated. Please store the not required Silicagel in an hermetically sealed jar.



Reduction of humidity

In the desiccators without automatic drying, the reduction of humidity occurs through the inserting of Silicagel. This desiccant has the property to bind humidity from the environment. If the desiccant is saturated, it can be regenerated. If humidity does not decrease as required, the Silicagel is already saturated or too less Silicagel is used. Increase the portion. Check if the door closes correctly or if the sealing is damaged. Check the displayed values of the built-in hygrometer by comparing with another one. In case the residual moisture is outside of the measuring range, the built-in hygrometer is not able to display correct values. You will find the detailed measuring range on page 80.



Faster decrease of humidity in your desiccator

You can put a little ventilator inside your desiccator for a better air circulation and thus a faster decrease of humidity. It can be driven by solar cells or a cable to an external power source. Normally, the cable of a transformer is thin enough to be lead into the desiccator through the sealing at the hinge side. Thick cables can be put in without difficulty because of the SICCO cable lead-in. The cable lead-in can be installed in a new desiccator.



Reduction of air exchange

When opening the door of the desiccator, the humid air from the environment intermixes with the dry air in the desiccator. In order to keep the air exchange as low as possible, form an artificial wall by putting large vessels in the front part of the desiccator. This barrier distracts the incoming air. In case of empty shelves, you can additionally glue a paper or a film in the gaps and thus reduce the circulation of air.



SICCO Cable lead-in

You can use electronic devices inside your desiccator with the specially designed cable lead-ins. The cable lead-in allows the complete cable to be pulled through the desiccator wall; there is no need to detach the plug. Multi-core and flat cables with a diameter between 0,1 and 10 mm are fixed and sealed safely.



round power cable with plug



bipolar power cable with SMP plug

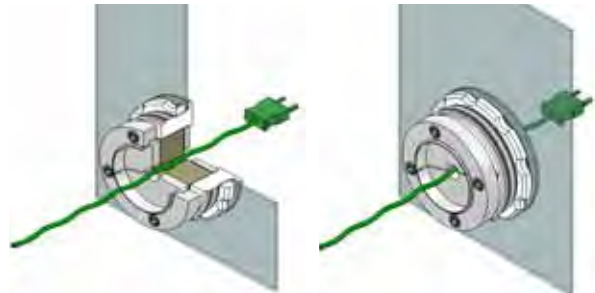

Tip: Even tubes with hard walls can be inserted and sealed tightly.



SICCO Gas Dosing Controller

The SICCO Gas Dosing Controller automatically controls the inlet of gas into a glove box or a desiccator. You simply adjust the required relative humidity directly on the Gas Dosing Controller (1). A sensor (2) inside the glove box constantly monitors the humidity, compares it to the adjusted value and leads in only the necessary amount of gas, e.g. nitrogen, into the glove box or desiccator.

For connecting the sensor and the tubing for gas filling two cable lead-ins are needed on the glove box as well as on the desiccator.

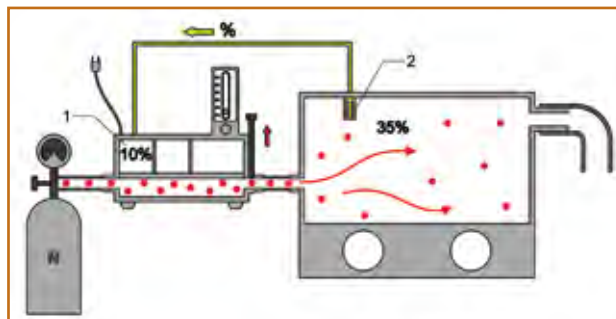

When the adjusted relative humidity (1) inside the glove box respectively inside the desiccator (3) is reached, the gas supply is stopped. The relative humidity will be kept on a constant level without any need for intervention.

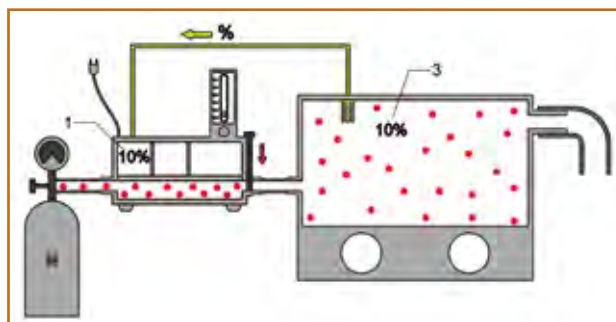

For your safety and the safety of your products an acoustic signal and a visual signal are activated if the measured humidity inside the glove box or the desiccator deviates for more than 5% of the adjusted value. This way you can immediately initiate countermeasures.

The SICCO Gas Dosing Controller not only increases the safety but also reduces the monitoring time to a minimum.

SICCO Gas-saving valve

By using the SICCO Gas-saving valve you can significantly reduce the gas consumption of your glove box.

The functional principal is very simplistic: depending on the strength of the gas flow the pass of the valve opens otherwise the valve is closed nearly gas-tightly. A complicated control and additional power supply are not necessary.

How it works:

Assemble the Gas-saving valve to the cable lead-in which you usually use to connect your aeration tubing and mount the aeration tubing on the hose connector.

During gas-filling the sealing ball is lifted due to the gas-flow and the passage to the aeration tubing is opened. The excess gas, which might lead to an overpressure in your glove box, is derived fast and damages are prevented.

When the gas-filling process is completed the airflow stops. The sealing ball drops due to its own weight and closes the passage nearly gas-tightly.

Vacuum can already occur when the gloves are pulled on or off, which can cause a backflow of the ambient air into the workspace of the glove box. By using the gas-saving valve the passage to the aeration tubing remains closed and the inert atmosphere inside the workspace can be kept for a longer period of time. The amount of additional purging processes and consequently the gas consumption can clearly be reduced.

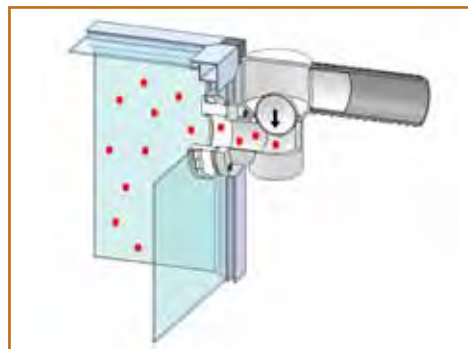
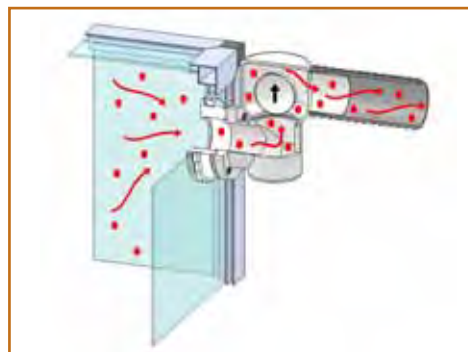

SICCO Iris-Ports

For a quick access to the work space and for applications that don't require an inert atmosphere SICCO Iris-Ports are a real alternative to the mounted gloves.

SICCO Iris-Ports consist of a stable ring made of polyethylene. Two slotted silicone discs are attached inside the ring. The overlapping segments of the crosswise slotted silicone discs allow at the same time an easy access to the work space and minimize the air exchange when the glove box is not in use.

The iris-ports are mounted to the already existing glove ports. After the gloves were removed the iris-port is fixed by rotating and simultaneously sliding it on the port.

Now you have direct access to the work space without putting on and removing the gloves.



SICCO Closing lid

Without the mounted gloves the glove ports are permanently opened. Therefore an unopposed air exchange with the environment happens which depending on the application may lead to contamination of the work space or to the outlet of hazardous powders and particles.

This can easily be prevented by using the SICCO Closing lid for glove ports. The lid is turned on the glove port and is kept in place by means of a silicone cord seal. The lid is not gas tight.





Robust construction, appealing design, sophisticated functionality: SICCO desiccators and drying cabinets leave nothing to be desired. That's BOHLENDER experience and know how gained from more than 30 years of delivering safe storage systems for sensitive items and materials.

We have always set high quality standards; all design, development and manufacturing are done in house by BOHLENDER professionals.

SICCO – built for those who expect more.

Extra flexibility

Depending on the kind of material, the quantity and how long you would like to store it, your requirements for a desiccator or a drying cabinet may change. Your needs set our benchmarks. Having design and production in house makes it possible efficiently to meet your requirements. We are sure you will find a suitable desiccator in our extensive product range. If not we can make custom units; we need a brief specification and our design department will start work to meet all your requirements.

Extra expertise

We listen to our customers! Desiccators and drying cabinets are part of BOHLENDER's product range since 1977. And since 1998, we have been manufacturing them in house. Based on your feedback, our products are continuously improved and adapted to meet your requirements. Should you have any questions or requests, our professional staff will give you expert advice. Who knows more about drying cabinets and desiccators than the manufacturer?



Extra service

Some enquiries are urgent. To meet customer needs we keep the majority of our products in stock. Our efficient, well-established workflow systems assure rapid shipment of your order whether it is for desiccators, drying cabinets or accessories. Waiting times and unnecessary downtime can be prevented. You have no time to lose? We are here to help.

Extra reliability

Valuable items or sensitive substances require reliable and safe storage. SICCO desiccators and drying cabinets are consistently designed and built for security and longevity. We use solid, shock resistant aluminium frames and high-quality, unbreakable acrylic panels which optionally are available either as antistatic or UV radiation resistant. Consistent, high quality inhouse manufacturing by our highly qualified staff complement a comprehensive quality assurance system. This results in desiccators and drying cabinets which are top of the class.

Extra features

Our goal is that you are completely satisfied using our products just as we enjoy developing and producing them.



The special appeal of SICCO desiccators and drying cabinets stems from the many well-thought details and unique features such as our innovative, magnetic locking system "One-Touch-Door". The door closes tightly but can easily be opened and closed with a light touch.

SICCO Materials & Glossary

PMMA

coll: acrylic glass
 also known under the tradename Plexiglas® of company Evonik Röhm GmbH
 Synthetic, thermoplastic material;
 Break proof and impact resistant;
 Very good surface, shiny; Good resistance to dilute acids and alkali, limited resistance to organic solvents; Flammable properties similar to hardwood;
 Very low production of smoke if burnt;
 Gases emitted when burning are neither toxic nor corrosive;
 Usable up to approx. +70 °C
 Volume resistivity: $>10^{15} \Omega/\text{cm}$, test specification DIN VDE 0303,
 Surface resistivity: $5 \times 10^{13} \Omega$, test specification DIN VDE 0303, part 3;
 Transmittance t_{D65} : ~92 %, test specification DIN 5036, part 3

PMMA orange

Properties: see above;
 t_{D65} = transmittance according to DIN 5036 at standard illuminant D65 (daylight, approx 6500 K, DIN 5033): 42 %
 a_{D65} = absorbance according to DIN 5036: 52 %

PC

Polycarbonates are plastics that belong to the group of synthetic polymers and to the family of polyesters. Polycarbonates are transparent and non-coloured but they can easily be coloured. The material is characterized by its high stability, impact resistance, stiffness as well as its rigidity. Polycarbonates are widely resistant against atmospheric conditions and radiation. They're flammable but can easily be extinguished by erasing the source of ignition. Moreover polycarbonates are good isolators. They're water resistant, resistant against many mineral acids and hydrous solutions of neutral salts and oxidants. Also some other non-polar organic solvents like carbon hydride and many oils and fat do not cause any damage to

polycarbonates. However polycarbonates aren't resistant against chlorinated carbon hydrides, e.g. dichloromethane. It is also instable against hydrous alkaline solutions, amines and ammonia.

PC-ESD

PC-ESD is made of transparent, two side coated permanent static dissipative material. The dissipative property reduces particle attraction and the generation of electrostatic fields. Complies with EN 61340-5-1 and ANSI/ESD S20.20-1999

Borosilicate glass

is crystal-clear, non-coloured and shows no significant absorption in the visible spectrum. The permeability of ultraviolet radiation allows it to use the products for photochemical reactions. The refraction index is at 1,472 (with 589,3 nm) and the photoelastic constant is B 3,6 10⁻⁶ MPa⁻¹. The physical properties of borosilicate glass are described in norm DIN ISO 3585. Borosilicate glass has a high chemical resistance against alcohols, water and acids and their mixtures, as well as chlorine, iodine, bromine. The interaction of water only has a small effect on the glass. A thin layer of fused quartz is built up which reduces a further attack on the glass.

Water resistance (ISO 719)

Water classification 1

Acid resistance (ISO 1776

Acid classification 1-2

Alcali resistance (ISO 695)

Alcali classification 2

Aluminium

This metal stands out due to its very low density of 2,7 g/cm³ (approx. 3 times lighter than steel) and is especially used for the frame and shelves.

Aluminium is very reactive right after being machined and therefore reacts with the substances of the surrounding environment, air and humidity, which covers the material with a protective oxide layer. This oxide layer prevents a further corroding of the aluminium but is dissolvable in acids and bases. Thus a direct contact with chemicals should be avoided.

Stainless Steel

Stainless steel is often used for the production of shelves, plates, collecting or protective trays which are an additional protection against leakage. Compared to plastics this material has a very good thermal conductivity. The high corrosion resistance can be generated by means of a nickel alloy. Stainless steel is not only suitable for the use with food but also for applications in the sectors pharmaceutical and biotechnology. In order to avoid an unwanted reaction with metal ions stainless steel should not get in contact with high purity chemicals of the semiconductor industry.

Silicagel

Silicagel is a colourless amorphous silicic acid with a gel-like consistency. It has a large inner surface area. It is very hygroscopic and can be used as gelling agent, filtering or absorption material and desiccant. Normally coupled with an indicator, Silicagel changes colour as soon as it absorbs water; the gel remains pourable and dimensionally stable even in saturated condition. It can be regenerated on a metallic sieve or on a baking tray at approx. 90–110 °C (a microwave oven is not suitable for regeneration!).

SICCO Materials & Glossary

EPDM Cellular rubber # (Ethylene-Propylene-Diene-Rubber)

This smooth product is used for example for the sealing tape of desiccator doors. It is produced in a so-called expansion manufacture and shows cells in the inside of the product which are not connected. That is why components or sealings made of a primary product through cut out do not lose their capability of sealing. EPDM Cellular rubber is extremely light-weight with a density of approx. 0,13g/cm³ and an excellent thermal insulator through its low thermal conductivity of approx. 0,04 Wm*K. The service temperature is limited from -40 °C to +100 °C (temporary 120 °C). It is resistant to many acids and bases in common concentrations, potassium and sodium combinations (such as saline solution), aqueous alum, detergents, photographic chemicals, cold ammonia, acetylene, alcohols, glycolbased antifreeze fluids and ozone respectively silicone oil. It is not resistant to hydrocarbons (oils, greases, petrol), chlorinated hydrocarbons such as methylene chloride or carbon tetrachloride as well as nitro compounds and concentrated nitric or hydrochloric acids.

Natural Silicone

This elastomer with very good permanently elastic properties is characterized by a wide range of applications. It is used as a neutral netting alkoxy-based 1K-Silicone grease and sealing compound for sealing plastic and glass panels, cable lead-ins and the Iris Port openings. The compatibility with strainless acrylic glass can be confirmed. During curing process small quantities of alcohol can be released. Therefore, a good ventilation has to be provided during treatment. Through interaction of the cured natural silicone with liquid or gaseous chemicals such as iodine, bromine or aldehyde containing substances, the sealing compound can change color. If necessary, experiments have to be made beforehand.

Dischargeable silicone

It is used for the sealing of discs, for sealing of cable lead-ins or the Iris Port openings and more applications where electrostatic discharging is required. The discharge capability is achieved through addition of sooty particles. The specific contact resistance as per DIN EN ISO 3915 (1999) is approx. 0,25 Ω x cm. During curing process small quantities of oxime connections can be released. Therefore, a good ventilation has to be provided during treatment. If the applicator uses materials which will be afterwards treated with dischargeable silicone, he should clarify beforehand that its contents do not change the product (color for example).

NR Natural Rubber (Polyisoprene)

"Natural Rubber" (NR) is used for gloves and other products with high-elastic properties. NR is the basic product of rubbers and is supplemented by silicone elastomers which are characterized by good elasticity at low temperatures, or by fluorine elastomers (FKM) or perfluorelastomers (FFKM) which are especially used at high temperatures or in direct contact with aggressive chemicals. NR is resistant to high-energy radiation. That is why the products made of this material can be gamma-sterilized and are suitable for food, pharma and nuclear industries. Alternatively, it can be sterilized in an autoclave at 120°C for preparation of sterile products. NR loses its elasticity at temperatures < -40 °C. The maximum operating temperature should not exceed +80 °C. Thanks to its resistance to alcohols, acids and bases, NR is widely applicable.

Dischargeable EPDM (Ethylen-Propylene-Diene-Rubber)

This synthetic rubber is used in dischargeable versions of products which contain sooty particles such as gloves. They are used if an electrostatic charging should be avoided in case of contact. Therefore it is especially suitable for the use in ex-protected applications (contact resistance 4,8 *10⁴ Ω * cm, DIN EN 1149-2, fulfils ATEX requirements) respectively in electronic industries. The contents are conform to current FDA positive list. They are valid as per the criteria of the pharmaceutical, medical and food markets. Dischargeable EPDM is suitable for repeated steam sterilization without sticking. However, the maximum possible operating temperature must not be exceeded. EPDM loses its elasticity at temperatures < -20 °C. The maximum operating temperature should not exceed +130 °C. The material is free of halogen and resistant to many oxidizing media.

Black glass fibre reinforced PA

This glass fibre reinforced thermoplast is mainly used for corner connections, hinges or rails. Due to its high rigidity glass fibre reinforced PA is preferably used for all kinds of structural parts. Because of the additional stabilisation the material has a very high hydrolysis resistance at a continuous service temperature of 130°C and also has a good resistance against most acids. Nonetheless the material should not get in contact with hydrofluoric acid or moderate respectively strong leaches. Furthermore glass fibre reinforced PA stands out due to its excellent insulation properties. A direct contact with open flames should be avoided due to the given combustibility.

SICCO Materials & Glossary

Natural PP

Gas-saving valves or cable lead-ins are products made of natural PP. The thermoplastic processable Polypropylene has a high hardness and stiffness, is insensitive to stress cracking and shows a better resilience. However low temperatures restrict the ductility. The continuous service temperature is +110°C, a temporary operation at a temperature of +140°C is possible.

Natural PP is combustible and thus should not get in direct contact with open flames. The material is resistant against aqueous solutions of inorganic salts as well as most inorganic acids and leaches, even at higher concentrations and temperatures up to 60°C. Natural PP is affected by oxidizing chemicals such as oleum, concentrated nitric acid or by halogens.

Black PP

This dyed, non-conductive thermoplastic material is used for Iris-Ports and connectors for exhaust system in the glove box as well as electrical boxes on the Automatic Desiccators. The black pigmentation serves especially for better identification of the plastic parts (e.g. compared with Plexiglas) and does not change the properties of the plastic. Properties and application recommendations correspond therefore to the ones of natural PP. The black color can change respectively completely disappear in case of contact with chemicals.

Conductive PE

By addition of sooty particles, Polyethylene gets electro-conductive properties. The particles avoid electrostatic charging. Although this material shows conductive properties (spec. surface resistivity < 10⁶ Ohm, DIN EN 60093, fulfils ATEX requirements), they are significantly lower than those of metals (spec. surface resistivity < 1 Ohm). Conductive PE is used for example for shelves of Mini Desiccators or for Conductive Cable lead-ins. As the material has a temperature application area from -20°C to +80 °C, its applications are limited to "extended room temperature". The material is flammable and should not come into contact with open flames.

White PBTP

A typical application for this thermoplastic Polybutylenterephthalate (PBTP) material are Silica Gel Trays in laboratories. It is characterized by a low moisture absorption (0,2 - 05 percent by weight), a high mechanical strength, shock resistance due to good impact strength and very good electrical insulation properties (spec. contact resistance > 1013 Ohm x cm). Trays made of natural PBTP retain their shape up to approx. +165 °C. The material is flammable and should, therefore, not come into contact with open flames. It is resistant to diluted acids and bases at ambient temperature, alcohols, hydrocarbons, ketones, ether, mineral oils, fuels and saline solutions.



Information on function and safety of dischargeable plastics and elastomers

Plastics and elastomers are characterized by good thermal and electrical insulation properties. If the application requires conductive (=high conductivity) respectively dischargeable properties (lower conductivity is sufficient), this will be achieved through the addition of sooty particles. Dischargeable plastics are used to avoid ignition sources through electrostatic charging (see ATEX regulation). In other applications, it protects electronic components from voltage peaks through electrostatic charging. The additional material of the sooty particles is not stable to strong oxidative attacks. In case of contact with aerial oxygen, the dischargeable properties of the plastic or the elastomers do not change. However, strongly oxidizing media such as ozone (O₃), hydrogen peroxide (H₂O₂) or strongly oxidizing acids (concentrated HNO₃) decompose the sooty particles so that the electrostatic chargeability is lost. This can be recognized on the weakening of the originally black color of the parts. Through examination of the surface resistance (in Ω as per IEC 60093) respectively the contact resistance (in Ω*cm as per IEC 60093), this filler diminution can be monitored quantitatively. If the chargeability falls below the specified values after a period of time, the component should be replaced by a new one. The original component safety is no longer given.

SICCO Glossary

Relative humidity

Percentage ratio between water vapor pressure and saturated water vapor pressure over a clear and even water surface. On this basis it is easy to evaluate how quickly evaporation will proceed or how large is the danger of condensation. The quantity of water vapor which would be needed for saturation increases with increasing temperature. Similarly the relative humidity of a given air mass falls with increasing temperature. Temperature is therefore an important factor in assessing relative humidity and condensation

Dew point

The dew point is the temperature at which an object (in case humidity exists) shows a balanced state of condensing and evaporating water, or in other words the water vapour starts to condense.



Desiccators and Drying Cabinets

Fax
+49 (0) 93 46 - 92 86-51

or by E-Mail:
inquiry@sicco.de

As a manufacturing company we can make products to your specifications. Send us a drawing or sketch together with answers to the questions listed below.

Return this form with contact details by **fax or e-mail** and we will be in touch to discuss details and give you a free, no obligation quote.

Desiccator Glove Box

Sender

Company _____
Department _____
Contact person _____
Date and time to call _____
Address or P. O. Box _____
Postal Code and City _____
Phone/Fax _____
E-Mail _____

- » Describe the desiccator / glove box required. _____
- » For which application do you need the desiccator / glove box? _____
- » Which are the critical outer or inner dimensions? _____
- » Specify which materials you would like to store / to work with. _____
- » Which kind of acrylic panels do you need? _____
- » How many shelves do you need? _____
- » What will be the max. weight/load? Per shelf? _____
- » Do you need accessories (e. g. cylinder lock, cable lead-ins, etc.)? _____
- » State quantities. _____
- » What is the budgetary price range per desiccator / glove box? _____

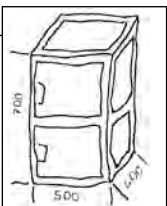

Large empty rectangular box for drawing or sketch.

Numerical Index

Cat. No.	Page	Cat. No.	Page	Cat. No.	Page
V 1705-08	74	V 1869-08	83	V 1974-09	85
V 1710-08	70	V 1871-07	12	V 1976-07	85
V 1715-08	72	V 1875-07	40	V 1982-08	63
V 1730-08	69	V 1877-07	47	V 1984-08	65
V 1735-08	71	V 1879-07	31	V 1986-08	64
V 1750-08	68	V 1880-04	58	V 1988-08	67
V 1760-07	16	V 1880-08	59	V 1992-08	66
V 1775-02	73	V 1880-12	59	V 1994-08	25
V 1777-05	84	V 1882-02	60	V 1995-08	50
V 1778-02	84	V 1891-07	35	V 1997-08	55
V 1779-02	84	V 1894-07	48		
V 1782-07	86	V 1895-04	81		
V 1783-07	86	V 1895-08	81		
V 1785-07	86	V 1895-12	81		
V 1787-07	85	V 1896-07	14		
V 1789-07	86	V 1897-07	16		
V 1790-07	86	V 1899-07	13		
V 1811-07	29	V 1901-04	80		
V 1821-07	27	V 1902-04	81		
V 1823-07	48	V 1903-04	80		
V 1825-07	41	V 1910-07	52		
V 1829-08	82	V 1914-01	49		
V 1830-07	18	V 1916-01	49		
V 1835-07	14	V 1922-07	53		
V 1840-06	38	V 1923-07	53		
V 1841-07	26	V 1925-07	52		
V 1842-06	33	V 1926-07	32		
V 1843-06	54	V 1927-07	32		
V 1844-07	27	V 1928-07	33		
V 1845-07	28	V 1930-07	17		
V 1846-07	28	V 1932-01	42		
V 1847-06	21	V 1933-01	43		
V 1848-06	22	V 1935-07	42		
V 1849-06	44	V 1936-07	36		
V 1850-01	19	V 1937-07	37		
V 1850-02	19	V 1938-07	13		
V 1850-03	19	V 1939-07	36		
V 1852-01	15	V 1940-06	38		
V 1853-01	15	V 1942-06	34		
V 1859-08	82	V 1943-06	54		
V 1860-02	80	V 1947-06	21		
V 1860-03	80	V 1948-06	22		
V 1860-05	79	V 1949-06	44		
V 1860-30	79	V 1950-01	20		
V 1860-51	78 / 79	V 1950-02	20		
V 1860-52	78	V 1950-03	20		
V 1860-55	78	V 1951-08	80		
V 1860-57	79	V 1951-16	80		
V 1860-61	78	V 1952-08	78 / 79		
V 1860-67	78	V 1952-16	78		
V 1860-68	78	V 1953-07	84		
V 1860-73	79	V 1954-07	84		
V 1860-75	79	V 1960-02	76		
V 1860-77	79	V 1960-04	76		
V 1861-07	81	V 1962-02	75		
V 1863-05	82	V 1963-02	75		
V 1863-07	82	V 1971-07	85		
V 1864-01	81	V 1972-07	85		
V 1866-07	82	V 1972-08	85		
V 1868-08	83	V 1972-09	85		

Alphabetical Index

A

Accessories	77 - 86
Antistatic Desiccators	51 - 55
Antistatic Gloves	85
Auto-Big-Star-Desiccator	48
Auto-Desiccator Wall	50
Automatic-Desiccators	45 - 50
Auto-Maxi 1-Desiccator	49
Auto-Maxi 2-Desiccator	49
Auto-Star-Desiccator	47
Auto-Star-Desiccator Vitrum	48

B

Big-Star-Desiccator	14
Big-Star-Desiccator Antistatic	50
Big-Star-Desiccator Black	36
Big-Star-Desiccator Low	16
Big-Star-Desiccator Protect	32
Big-Star-Vitrum-Desiccator	27

C

Cable lead-in	86 / 101
Cable lead-in Antistatic	86 / 101
Cable lead-in Iris-Port	86
Cleaning of desiccators	87
Closing lid for glove port	86 / 104
Collecting tray for Maxi 1 and 2, Big-Star	80
Collecting tray for Star-Desiccators	78 - 79
Company	105 - 106
Conductive Desiccators	51 - 55
Conductive Gloves	85
Connecting kit for gas-filling (Glove Boxes)	86
Connectors for Desiccators	84 / 98
Connectors for gas-filling (Desiccators)	81
Custom manufacture	9

D

Desiccant - proper use and regeneration	99
Desiccant Cartridge	80
Desiccant Cylinder	81
Desiccators for drying/storage	11 - 38
Desiccators for gas-filling	39 - 44
Desiccators of glass	26 - 29
Desiccator Wall	25
Desiccator Wall Antistatic	55
Desiccators with earthing connection	51 - 55
Dolly Desiccator	16
Drying performance of Desiccators	88 - 95

E

Electronic Dehumidification System Automatic Desiccators	46
Extractor Hoods	76

F

Fields of application of Desiccators	6 - 7
--------------------------------------	-------

G

Gas Dosing Controller	73 / 102
Gas-saving valve	85 / 103
Glove Box	65
Glove Box Duo 1 with Transfer Chambers	69
Glove Box Duo 1 with Transfer Chambers Antistatic	71
Glove Box Duo 2 with Transfer Chamber	70
Glove Box Duo 2 with Transfer Chamber Antistatic	72
Glove Box for Exhaustion	68

Glove Box Trio with Transfer Chamber	68
Glove Box Vitrum with Transfer Chamber	64
Glove Box with Transfer Chamber	63
Glove Box with Transfer Chamber Antistatic	66
Gloves	85
Gloves Antistatic	85
Grounded Desiccators	51 - 55
Guide to your ideal product	10

H

Heated Desiccators	18
Hoses for gas-filling (desiccators)	79
Horizontal-Star-Desiccator	13
Horizontal-Star-Desiccator Vitrum	27
Humidity reduction	99 - 100
Humidity-Temperature Probe with USB-Interface	83
Hygrometer	82

I

Iris-Ports	85 / 104
------------	----------

L

Lead-in for cables	84 / 89
Lead-in for cables Antistatic	84
Light-protected Desiccators	31 - 43
Lockable Desiccators	21 / 40 / 41

M

Made to measure	9
Maintenance Kits	84
Materials	107 - 109
Maxi 1-Desiccator	15
Maxi 1-Desiccator Antistatic	53
Maxi 1-Desiccator Black	36
Maxi 1-Desiccator Horizontal	14
Maxi 1-Desiccator Protect	32
Maxi 1-Vitrum-Desiccator	28
Maxi 2-Desiccator	15
Maxi 2-Desiccator Antistatic	53
Maxi 2-Desiccator Black	37
Maxi 2-Desiccator Protect	33
Maxi 2-Vitrum-Desiccator	28
Mini 1-Desiccator Basic	19
Mini 1-Desiccator Premium	20
Mini 2-Desiccator Basic	19
Mini 2-Desiccator Premium	20
Mini 3-Desiccator Basic	19
Mini 3-Desiccator Premium	20
Mini-Desiccator Antistatic Basic	54
Mini-Desiccator Antistatic Premium	54
Mini-Desiccator Black Basic	38
Mini-Desiccator Black Premium	38
Mini-Desiccator for Gas-Filling Basic	44
Mini-Desiccator for Gas-Filling Premium	44
Mini-Desiccator Protect Basic	33
Mini-Desiccator Protect Premium	34
Mini-Desiccator Secure Box Basic	21
Mini-Desiccator Secure Box Premium	21
Mini Glove Box	74
Mini-Mobile-Desiccator Basic	22
Mini-Mobile-Desiccator Premium	22
Mobile Desiccators	22
Modifications	8

P	
Portable Desiccators	22
Protective tray for Glove Box	85
R	
Rack for Glove Box	75
Reduction of air exchange	100
Reduction of humidity	99 - 100
Regeneration of Silicagel	99
S	
Safe stacking of Desiccators	98
Safe wall fastening	98
Shelf for Maxi 1 and 2, Big-Star	80
Shelf for Mini-Desiccator	79
Shelf for Star-Desiccator Antistatic	78
Shelf for Star-Desiccators Horizontal	79
Shelf for Star-Desiccators	78 - 79
Shelf for Vacuum-Desiccator	79
Silicagel	80 - 81
Stacking of desiccators	98
Star-Desiccator	12
Star-Desiccator Antistatic	52
Star-Desiccator Black	35
Star-Desiccator Double	17
Star-Desiccator Horizontal	13
Star-Desiccator Protect	31
Star-Thermo-Desiccator	18
Star-Vitrum-Desiccator	26
Star-Vitrum-Desiccator Horizontal	27
Super-Big-Star-Desiccator	42
Super-Maxi 1-Desiccator	42
Super-Maxi 2-Desiccator	43
Super-Star-Desiccator	40
Super-Star-Desiccator Vitrum	41
Suspension arrangements and rails	97
T	
Technical Information	87 - 104
Temperature adjustable Desiccators	18
Temperature-Humidity Probe with USB-Connector	83
Tips	98 - 104
Tower-Star-Desiccator	13
Tray for Glove Box	85
Tray for Silicagel	81
U	
USB-Datalogger	83
V	
Vacuum 1-Desiccator	58
Vacuum 2-Desiccator	59
Vacuum 3-Desiccator	59
Vacuum-Desiccators	57 - 60
Vacuum-Desiccator Toploader	60
Valve for Glove Box	85 / 103
W	
Wall Fastening Kit for Star Desiccators	84 / 98



СОВ  **ЛАБ**
КОМПЛЕКСНОЕ ОСНАЩЕНИЕ
+7(916)414-93-61 www.sov-lab.ru
+7(495)045-58-29 sov_lab@mail.ru

SICCO

A PRODUCT BRAND OF
BOHLENDER GmbH
Waltersberg 8
D 97947 Grünsfeld
Germany

Phone: +49 (0) 93 46 - 92 86-0
Fax: +49 (0) 93 46 - 92 86-51
Mail: info@sicco.de
www.sicco.de